

SIRUBA

電控參數說明書

ELECTRONIC CONTROL PARAMETER MANUAL

700KS/KST

700KS-LFD6K

F007K FNC(CE)

VC008(CE)

VC008A/B(CE)

HF008A(CE)

HF008(CE)



EC - Manufacturer Declaration

We declare herewith that the following equipment :

NEEDLE POSITIONER

AC SERVO MOTOR--- TD SERIES

. is designed to be a driver of a sewing unit or system and must not be put into commission until the sewing unit or system has been declared in conformity with the provision of the EC Machinery Directives.

. complies with the following relevant provisions:

- EC Low Voltage Directive (2014/35/EU)
- EC Electromagnetic Compatibility Directive (2014/30/EU)
- EC Machinery Directive (2006/42/EC)

Applied harmonized standards, especially :

EN ISO 12100:2100-Safety of machines. General principles for design / Risk Assessment and Risk reduction.

EN 60204-1:2006/AC:2010 - Safety of machinery-Electrical equipment of machines.

Part1:General requirements.

EN 60204-31:2013 / Safety of machinery - Electrical equipment of machines.

Part 31: Particular safety and EMC requirements for sewing machines, units and systems.

有毒物質限量指令自我宣告書

Declaration of Conformity for Concentration Limits for Certain Hazardous Substances

本公司所生產之伺服馬達產品系列如下所列：

We declare herewith that the following AC servo motor series products list below：

AC 伺服馬達--- i 系列/ G 系列/ GD 系列/ MD 系列 / TD 系列

AC Servo Motor --- i Series / G Series / GD Series / MD Series/ TD Series

Device---TK Series / TC Series / MK Series / MC Series

皆符合以下指令及要求：

Are complies with the following directives and requirements:

1. 歐盟 RoHS 指令 (2011/65/EU) 及有毒物質的限量要求 ((EU)2015/863)
2. 中華人民共和國電子行業標準：電子信息產品中有毒有害物質的限量要求 (SJ/T 11363-2006)

1. European Union RoHS Directive (2011/65/EU) and the concentration limits for certain hazardous substances ((EU)2015/863).
2. People's Republic of China Electronic Business Standard : Requirements for concentration limits for certain hazardous substances in electronic information products (SJ/T 11363-2006).

本公司產品本身(馬達,控制箱)或其包裝材料及附件(紙箱,螺絲配件包,說明書,貼紙,標籤,印刷品...等等)或其元件與原材料供應商皆依照歐盟 RoHS 指令及中華人民共和國電子行業標準的限量規定而符合以下所列之十種有毒物質的限量要求：

Our product itself (motor, control box) or its packing materials and accessories (box, screws package, user manual, sticker, label, print...etc.) or the suppliers of parts and raw materials are all in conformity with the provision of the European Union RoHS Directive and People's Republic of China Electronic Business Standard to conform the following concentration limits for the ten hazardous substances：

有毒物質 / Hazardous Substance	限量要求 / Permissible Values
鉛 Lead (Pb)	低於 1000 ppm / Less than 1000 ppm
汞 Mercury (Hg)	低於 1000 ppm / Less than 1000 ppm
鎘 Cadmium (Cd)	低於 100 ppm / Less than 100 ppm
六價鉻 Hexavalent chromium (Cr VI)	低於 1000 ppm / Less than 1000 ppm
多溴聯苯 Polybrominated Biphenyl (PBB)	低於 1000 ppm / Less than 1000 ppm
多溴二苯醚 Polybrominated Diphenyl ether (PBDE)	低於 1000 ppm / Less than 1000 ppm
鄰苯二甲酸二酯 Di(2-ethylhexyl)phthalate (DEHP)	低於 1000 ppm / Less than 1000 ppm
鄰苯二甲酸丁酯苯甲酯 Butyl Benzyl Phthalate (BBP)	低於 1000 ppm / Less than 1000 ppm
鄰苯二甲酸二丁酯 Dibutyl phthalate (DBP)	低於 1000 ppm / Less than 1000 ppm
鄰苯二甲酸二異丁酯 Diisobutyl phthalate (DIBP)	低於 1000 ppm / Less than 1000 ppm

* 基板的無鉛製程：總鉛含有濃度基準量 800 ppm 以下。

* The concentration of lead in the lead-free process for PCB shall be less than 800 ppm.

* 包裝材料：Pb+Hg+Cd+Cr VI 含有濃度基準總共合計 80 ppm 以下。

* For packing materials shipped with our products or parts, the hazardous substances shall be 80 ppm or less in sum of Pb+Hg+Cd+Cr VI.

型 式： TD 系列

目 次

	頁次
1.安全上的注意事項	
1.1 作業環境的安全	1
1.2 安裝的安全	1
1.3 操作中的安全	2
1.4 保養維修的安全	2
1.5 保養維修的規定	2
1.6 危險標示、注意標示	2
1.7 保固期限規定	2
2.安裝與調整	
(1). 馬達的安裝	3
(2). 控制箱的安裝	4
(3). 控速器的安裝	4
(4). 控速器前、後踏力量調整.....	4
3.接線與接地	
(1). 電源線的接法	5
(2). 當電源系統配置為三相四線式 380 V，欲使用單相 220 V 供應伺服電機時的接線方式	5
(3). 當單相 220 V 伺服電機欲使用在三相 220 V 的電壓時，須注意配置使用上的負載平衡	6
4.控制箱各部位名稱	
(1). 控制箱正面	7
(2). 控制箱背面	7
5.LED 字幕畫面的顯示模式	
(1). 在【一般模式】畫面區，面板按鍵的功能與定義	8
(2). 如何進入第一階【參數模式 A】畫面區的操作步驟.....	8
(3). 如何進入第二階【參數模式 B】畫面區的操作步驟.....	9
(4). 在【參數模式 A 與 B】畫面區時，面板按鍵的功能與定義	10
(5). 如何進入『參數內容區』進行調整設定.....	10
6.常用參數內容表	12

封底： 七段顯示器字體與實際數值對照表

1.安全上的注意事項：

使用前請詳細閱讀本技術資料與所搭配的縫製機械說明書，配合正確使用，並須由接受過正確訓練的人員來安裝或操作。

在使用或安裝 TD 型伺服馬達系列控制箱驅動裝置時，請注意下列事項。

本驅動裝置僅適用於指定範圍的縫製機械，請勿移做其他用途。

1.1 作業環境的安全：

(1).電源電壓：

電源電壓請遵照控制箱銘牌所標示之規格 $\pm 10\%$ 範圍內操作。

(2).電磁波干擾：

請遠離高週磁波機器或電波發射器等，以免所產生的電磁波干擾本驅動裝置因而發生錯誤動作。



(3).溫濕度：

- 請不要在室溫 45°C 以上或 5°C 以下的場所操作。
- 請不要在日光直接照射的場所或室外運作。
- 請不要在暖氣 (電熱器) 旁運作。
- 請不要在相對濕度 30% 以下或 95% 以上或有露水的場所運作。

(4).空氣：

- 請不要在多灰塵或具有腐蝕性物質的場所操作。
- 請不要在有揮發性氣體的場所操作。

1.2 安裝的安全：

(1).馬達、控制箱：請遵照說明書正確裝好。

(2).附屬品：如要裝配其它選購配件或附屬品時，請先關閉電源並拔掉電源線插頭。

(3).電源線：

- 請注意不要被外物壓住或過度扭曲電源線。
- 當連接電源線到電源插座時，應確定此供應電壓必須符合標示在控制箱銘牌上的指定電壓 $\pm 10\%$ 內。

※注意：控制箱電源系統為 **AC 220V** 時，請勿插接到 **AC 380V** 的電源插座上，否則將出現錯誤碼 **E4**。此時請立即關閉電源開關，重新檢查電源。持續供應 380V 超過五分鐘以上，將會燒毀基板而危及人身安全。



(4).接地：

a.為防止雜訊干擾或漏電事故，請做好接地工程。(包括縫紉機、馬達、控制箱)

單相接線
(AC220V)

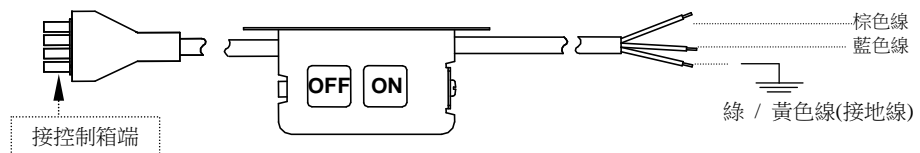

b.電源線的接地線須以適當大小的導線和接頭連接到生產工廠的系統地線，此連接必須被永久固定。

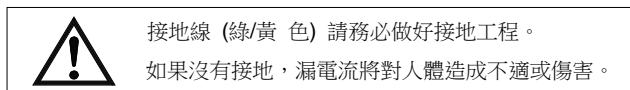

1.3 操作中的安全：

- (1).在第一次開電後，請先以低速操作縫紉機並檢查轉動方向是否正確。
- (2).縫紉機運轉時，請不要去觸摸天枰、針等會作動的部位。
- (3).所有可作動的部份，必須以所提供的防護裝置加以隔離，防止身體接觸並請勿在裝置內塞入其他物品。
- (4).請不要在拆下其他安全裝置的情形下操作。

1.4 保養維修的安全：

在操作以下動作前，請先關閉電源：

- (1).要拆卸馬達或控制箱時，或在控制箱上插或拔任何連接插頭時。
- (2).控制箱裡面有危險高壓電，所以關閉電源後要等 5 分鐘以上方可打開控制箱蓋。

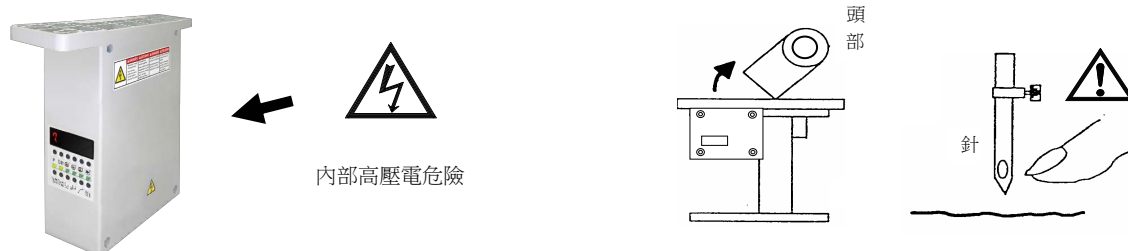



- (3).翻抬車頭時，與更換車針或梭子或穿線時。(如上圖示)
- (4).修理或作任何機械上的調整時。
- (5).機器休息不用時。

1.5 保養維修的規定：

- (1).修理及保養的作業，要請經過訓練的技術人員執行。
- (2).馬達的通風口附近，請不要堆置雜物阻塞空氣流通，尤其馬達後風蓋上更不可附著灰塵、紙屑、布屑等物，以免造成馬達發燙。
- (3).請不要以不適當物體，如木槌、鐵槌等敲擊本產品裝置或馬達(電機)心軸。
- (4).所有維修用的零件，須由本公司提供或認可，方可使用。

1.6 危險標示、注意標示

-  這個標示符號表示機器安裝時，如有錯誤恐會傷害到人體或機器會受到損壞，所以機器方面有危險性的地方會有此標示。
-  這個標示符號表示有高壓電，電氣方面有危險性的地方會有此標示。

1.7 保固期限規定：

本裝置保證在正常工作情況且無人為失誤的操作下，保證出廠 18 個月內，無償的為客戶維修使能正常操作。

2. 安裝與調整

(1).馬達的安裝：

M5 直驅型:

拷克車馬達的安裝方式

- 1.將車頭的散熱風扇及皮帶輪卸下。
- 2.將附件的聯軸器(A)放入車頭心軸內，散熱風扇端靠緊心軸端面。並使用心軸墊環(B)將聯軸器確實固定於車頭心軸。注意：車頭心軸端面若無預留螺絲孔則不組裝心軸墊環。
- 3.固定聯軸器的 set 螺絲(C)。注意：聯軸器特殊爪型的 set 螺絲固定於心軸平面或凹槽上(D)。
- 4.將 M5 馬達 E 固定於車頭端面上。
注意：車頭端聯軸器與馬達端聯軸器有防呆設計，組裝時需注意配合方向。
5. 固定馬達隔熱罩(F)。

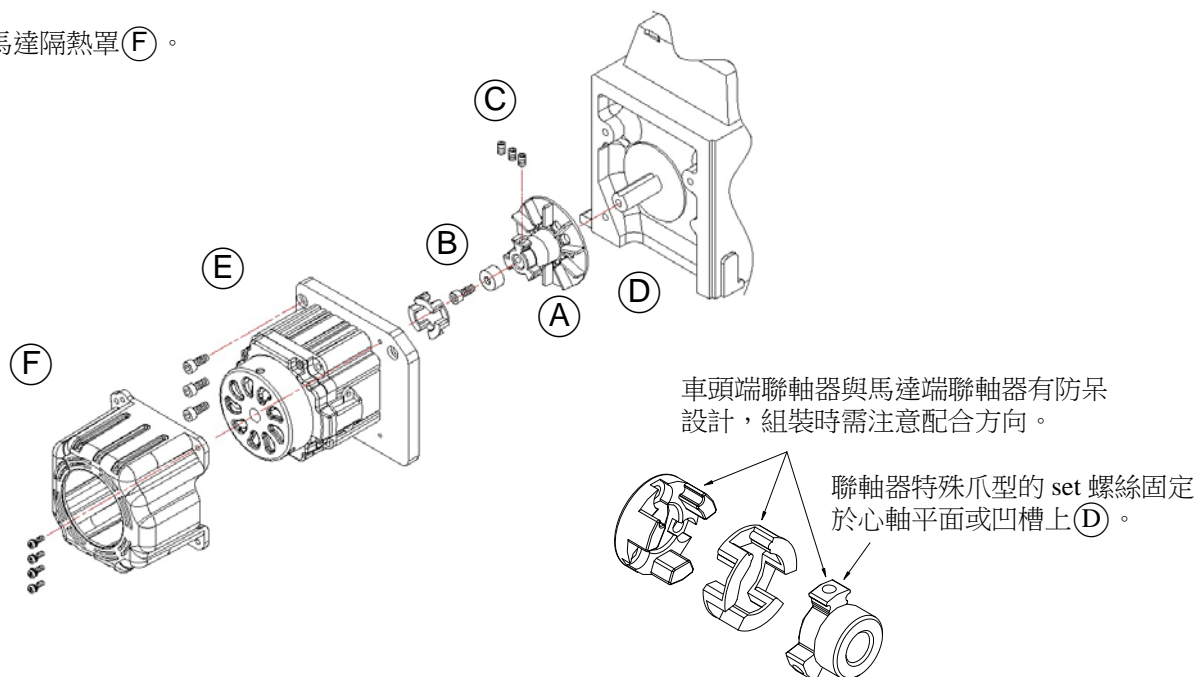

拷克車馬達的定位調整

1. 請先取下車頭手輪。
2. 轉動心軸使天秤停在最高點位置 (或車頭指定之上停針位置點)。
3. 轉動反光片座使螺絲(A)對準馬達出口線位置。

註：上述調整為標準調法，

如覺得定位不準，

可自行進行微調。

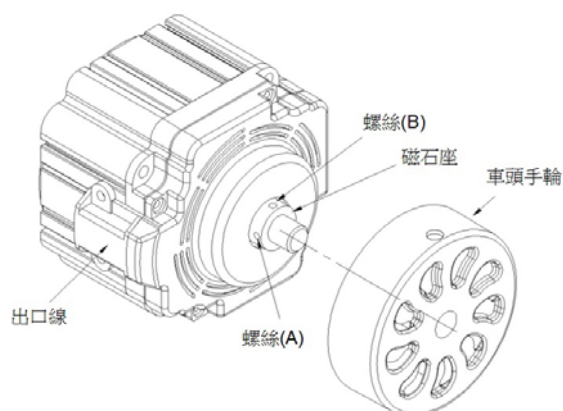

(2).控制箱的安裝：

a).車板右側面須預留 100 mm 以上空間

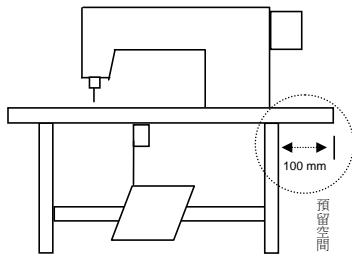

b).將 TD 控制箱鎖裝於車板下方
尺寸圖



c).安裝後示意圖

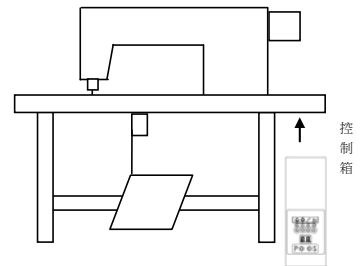

(3).控速器的安裝：

a.將控速器連座鎖於車板下方

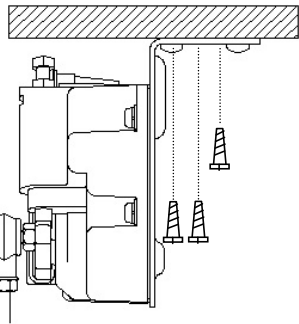

b.安裝後示意圖

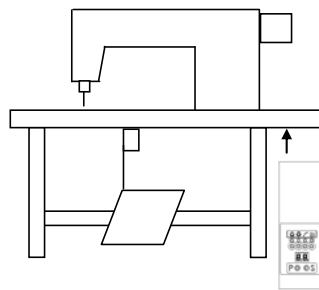

(4).控速器前、後踏力量的調整：

控速器各部位名稱：如下列圖示

- A：前踏力量彈簧。
- B：後踏力量的調整螺栓。
- C：踏板旋臂。
- D：腳踏板吊桿。

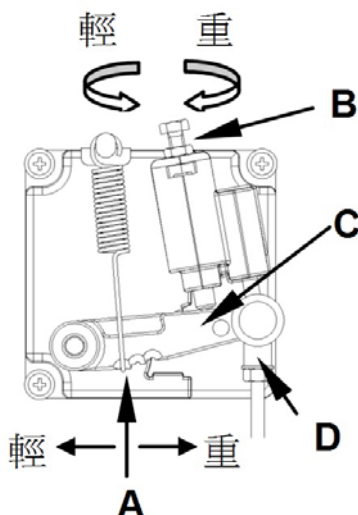

調整需求		調整結果
1	踏板前踏力量的調整	當彈簧 A 愈向右側勾時，表示力量愈重。 當彈簧 A 愈向左側勾時，表示力量愈輕。
2	踏板後踏力量的調整	當螺栓 B 愈向上 ↶ 時，則後踏力量愈輕。 當螺栓 B 愈向下 ↷ 時，則後踏力量愈重。
3	踏板行程長短的調整	當吊桿 D 向右側孔鎖裝時，表示行程較長。 當吊桿 D 向左側孔鎖裝時，表示行程較短。

3. 接線與接地：

(1). 電源線的接法：



綠/黃色電線為接地線，一定要做好系統的接地工，請洽合格的電氣工程人員予以施工程。

(2). 當電源系統配置為三相四線式 380V 時，欲使用單相 220 V 供應本電機的接線方式。



注意：如果此配置系統沒有【中性(點)線】時，則單相 220V 的伺服馬達不適合在此場所使用，請向原供應商改訂購本廠牌之三相 380V 的伺服馬達機型。

注意：必須要有中性(點)線的配置

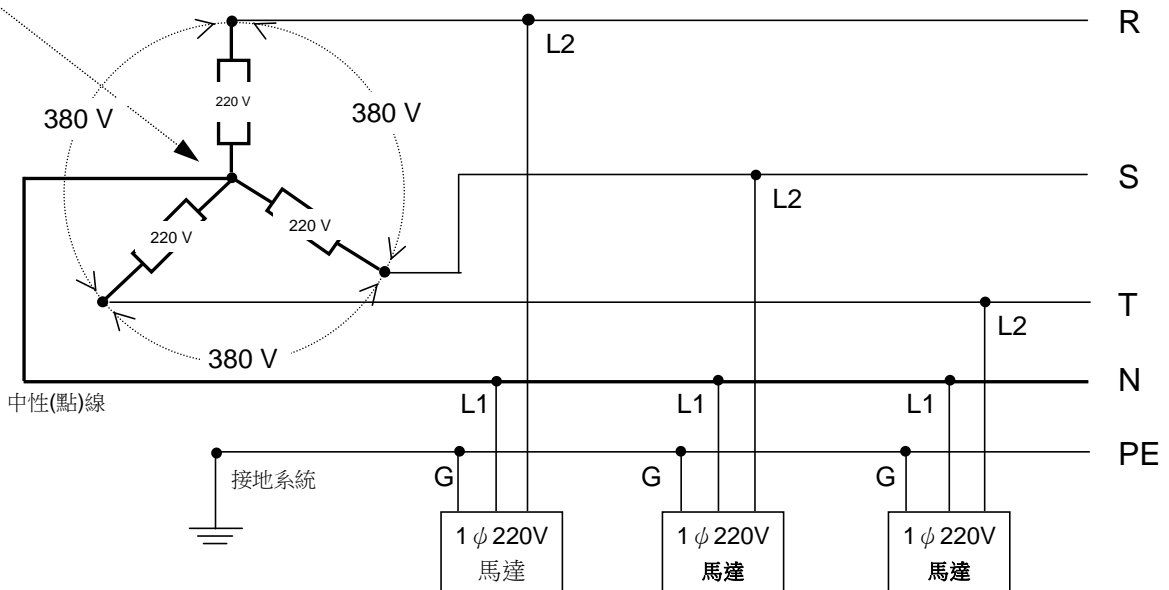

(3).當單相 220 V 伺服馬達欲使用在三相 220V 的電壓時，須注意配置使用上的負載平衡：
連接相當多數量縫紉機配置使用時，需考慮三相中 R、S、T 各相的平衡，如下圖示：

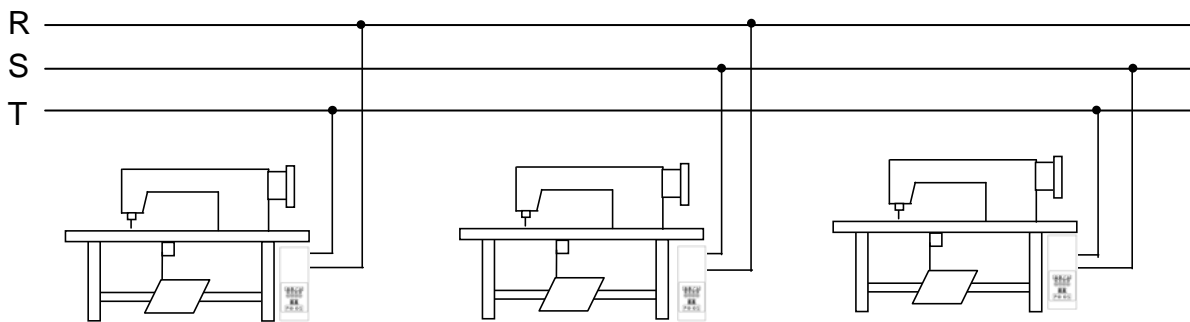

 **注意：**
在打開控制箱蓋之前，請先將電源關閉
約 5 分鐘後，再執行如下插接動作。



 ←
內部高壓電危險

4.控制箱各部位的名稱：

(1).控制箱正面：

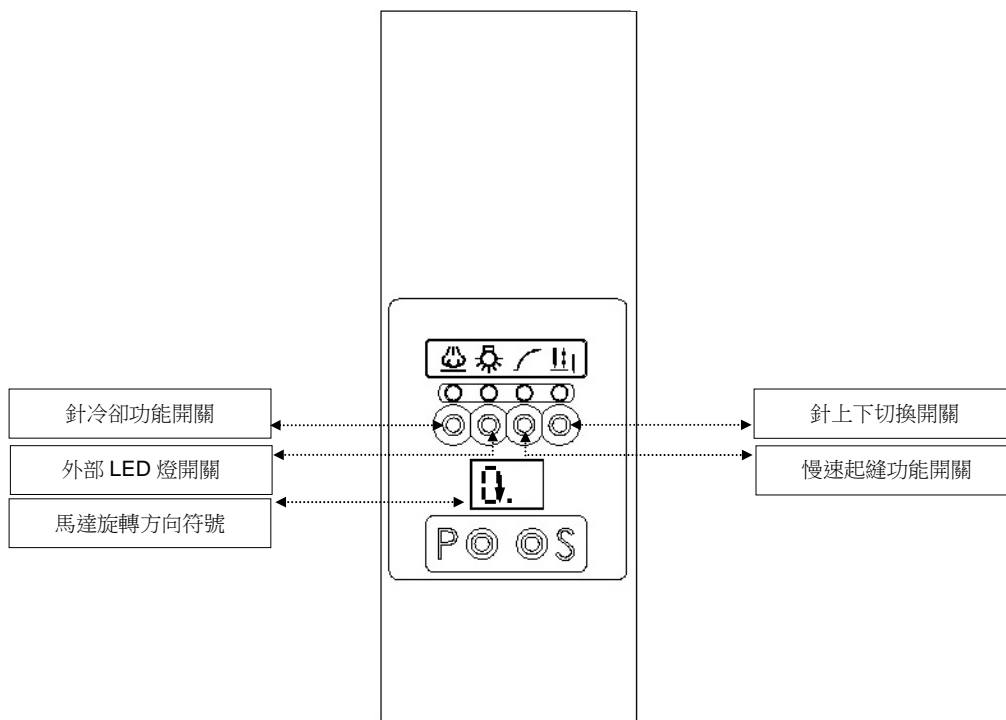

(2).控制箱背面：端子座面板

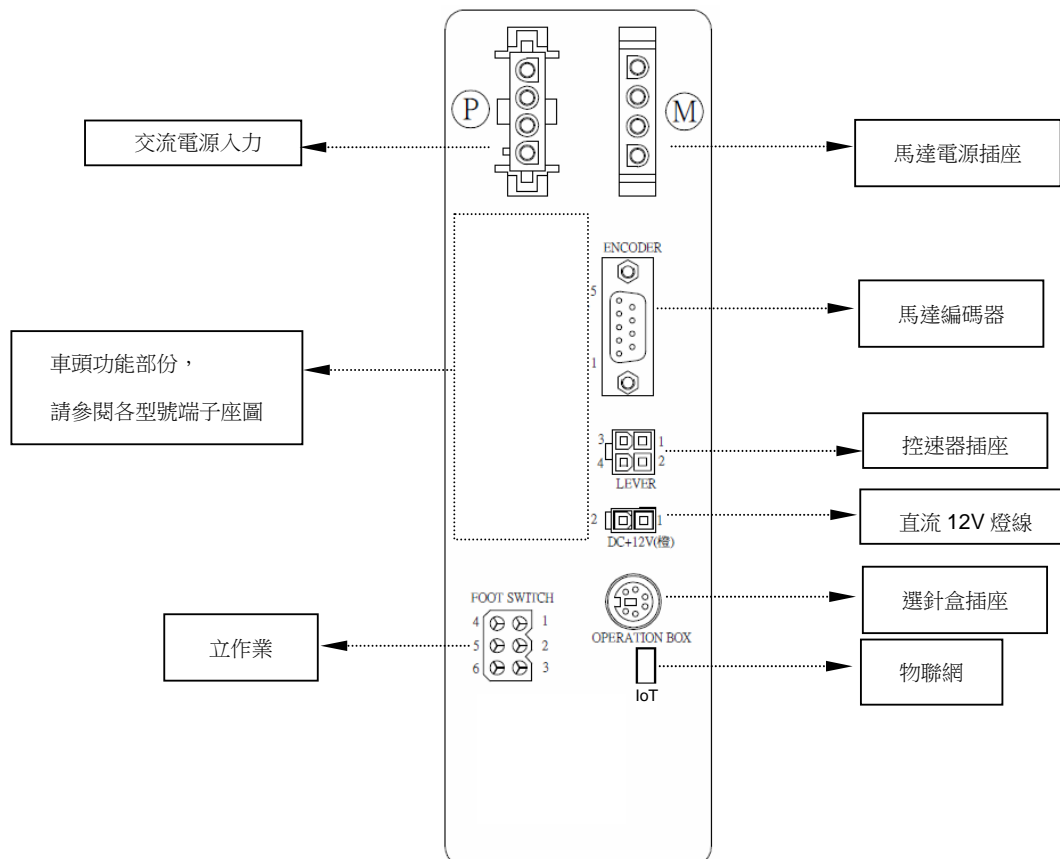

TD654-0-7K-2端子座圖

Connector panel diagram

DC+12V LAMP		
1	LED_0V	LED_0V
2	+12V	+12V



OUTPUT1		
1	OC(1A)	ASL
2	OF(1A)	AFL
3	O2(1A)	NCL
4	OA(1A)	TK
5	+24V	+24V
6	+24V	+24V
7	+24V	+24V
8	+24V	+24V

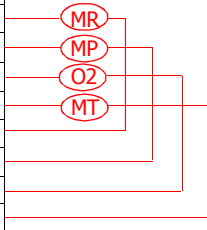

INPUT		
1	+24V	+24V
2	INB	PSD
3	IN1	KS1 SW.
4	---	PULSE OUT
5	0V	0V
6	0V	0V

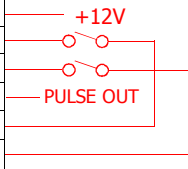

FOOT SWITCH		
1	+12V	+12V
2	ING	START
3	VC	VC1
4	INF	KNEE SW.
5	0V	0V
6	INH	TM SW.

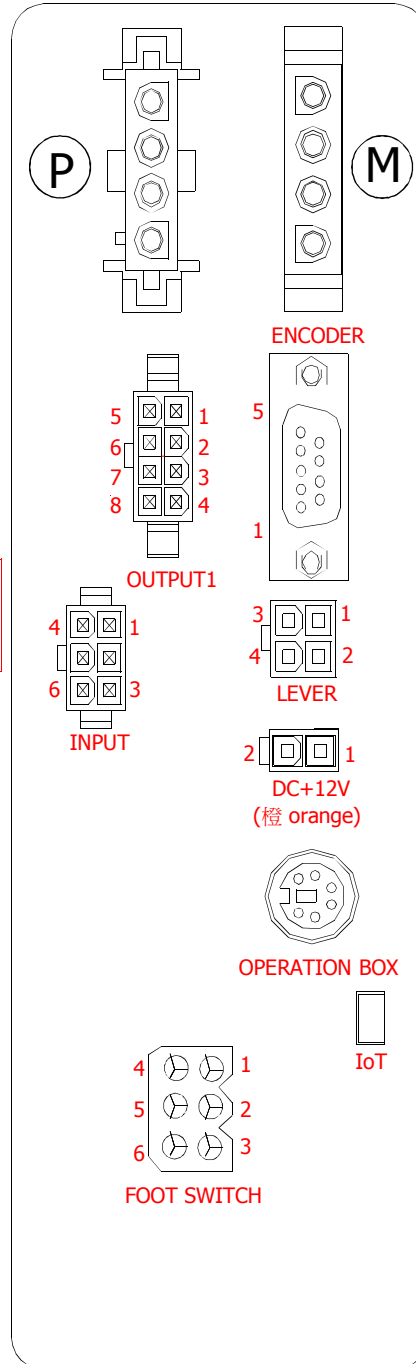
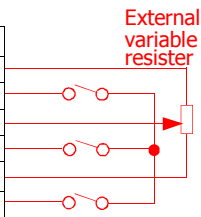

ENCODER	
1	+5V
2	UP
3	DOWN
4	A PHASE
5	B PHASE
6	R
7	S
8	T
9	0V

LEVER	
1	+5V
2	VC
3	KNEE SW.
4	0V

OPERATION BOX	
1	U SW.
2	R1in
3	+12V
4	T1out
5	0V
6	CKU

IoT	
1	+5V
2	T1out
3	R1in
4	---
5	0V

TD654-0-LF-2 端子座圖

Connector panel diagram

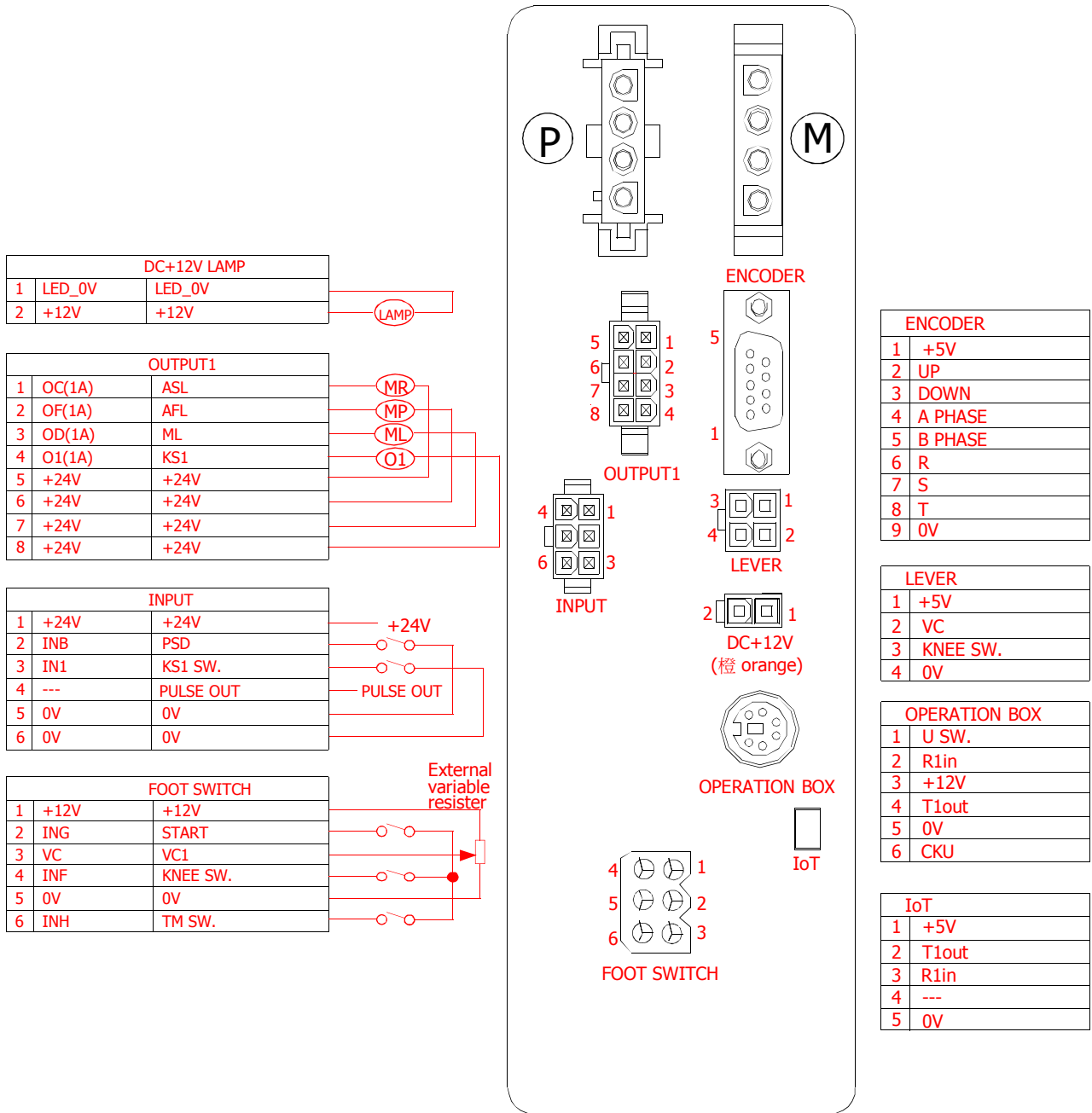

TD656-4-HF-2 端子座圖

Connector panel diagram

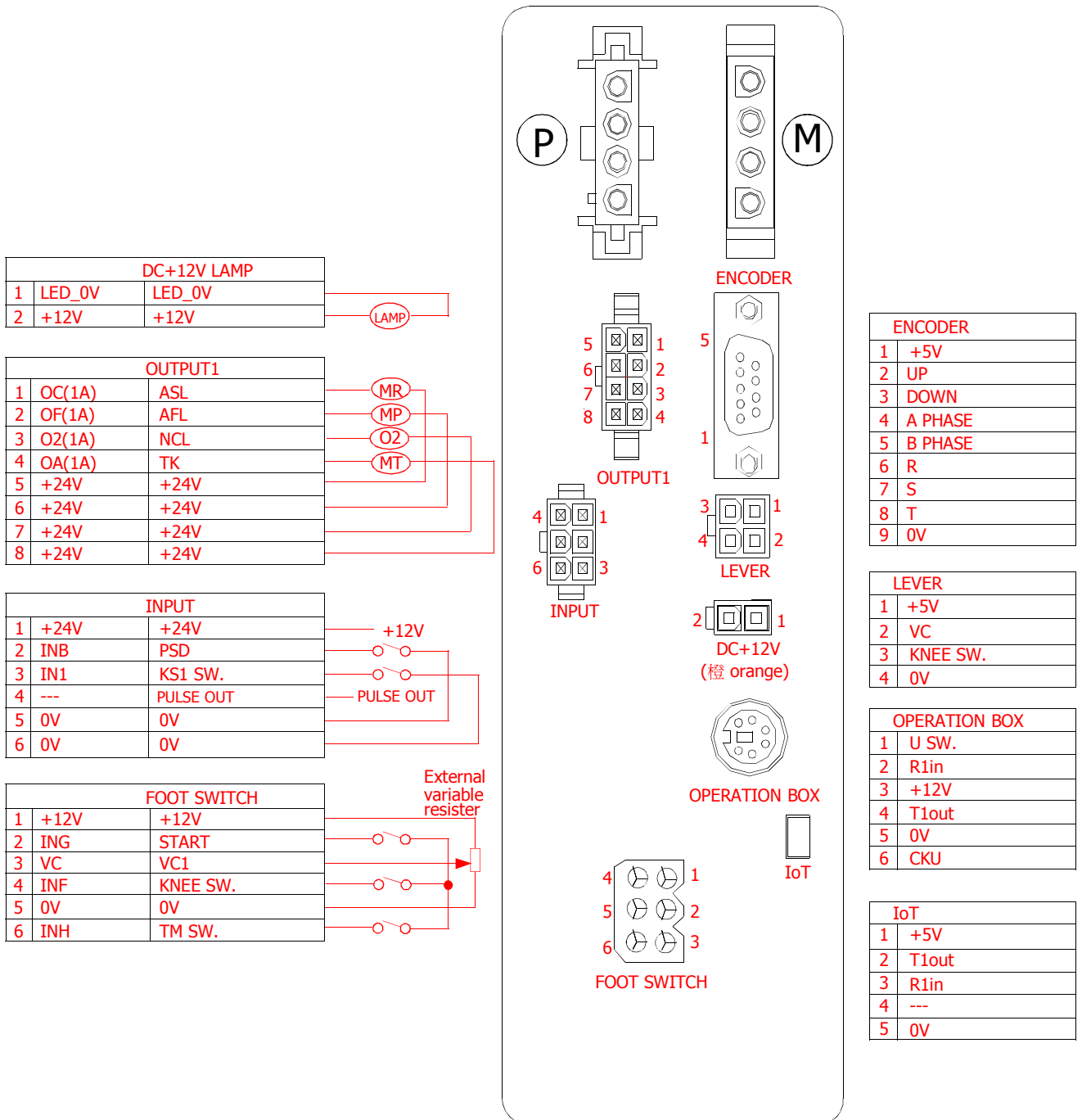

5.LED 字幕畫面的顯示模式：

(1).在【一般模式】畫面區，面板按鍵的功能與定義：

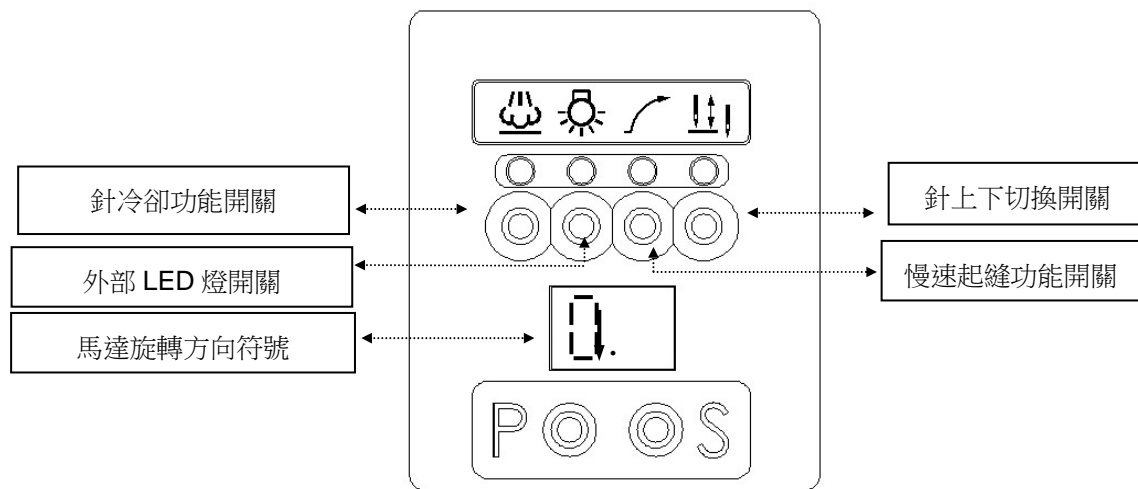

(2).如何進入第一階【參數模式 A】畫面區的操作步驟：(A 區僅可選參數為：01~46)

- 在【一般模式】畫面區按一下 P 鍵，即可進入【參數模式 A】的第一個參數【01】的畫面。
- 再以 P 鍵找出欲設定的參數序號，如範例：【05】。
- 按 S 鍵進入其【內容值】畫面區。
- 進入內容區後再按回 P 鍵調整所須之內容值。
- 再按 S 鍵予以儲存後回至操作區。

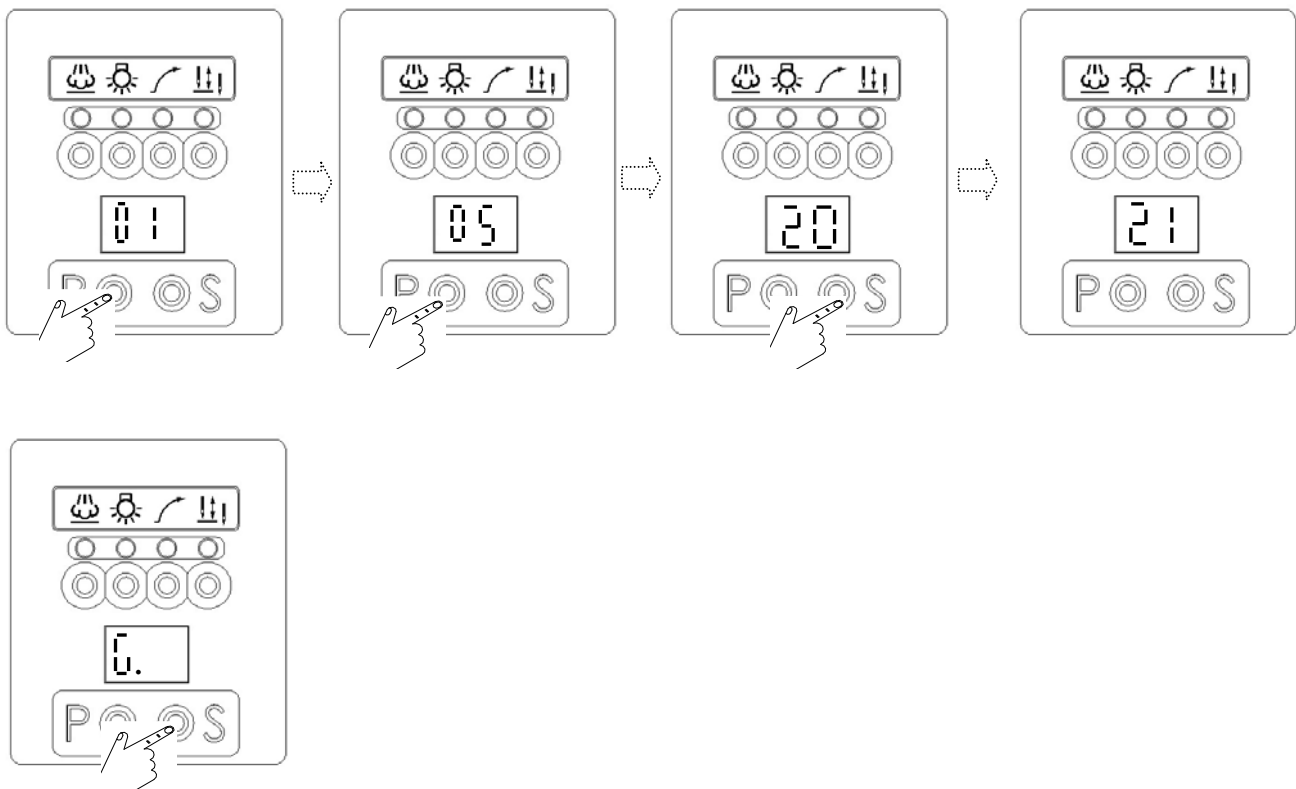

(3).如何進入第二階【參數模式 B】畫面區的操作步驟：(B 區可選參數範圍為：47~122)

a.如在操作中，請先關閉電源開關

b.以手按住 P 鍵，同時開啟電源開關，即進入【參數模式 B】畫面區中的第一個畫面【47】。

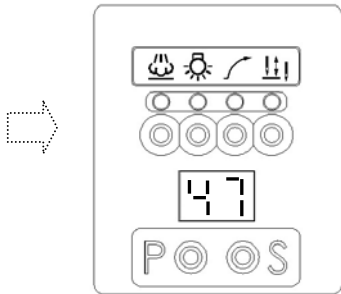
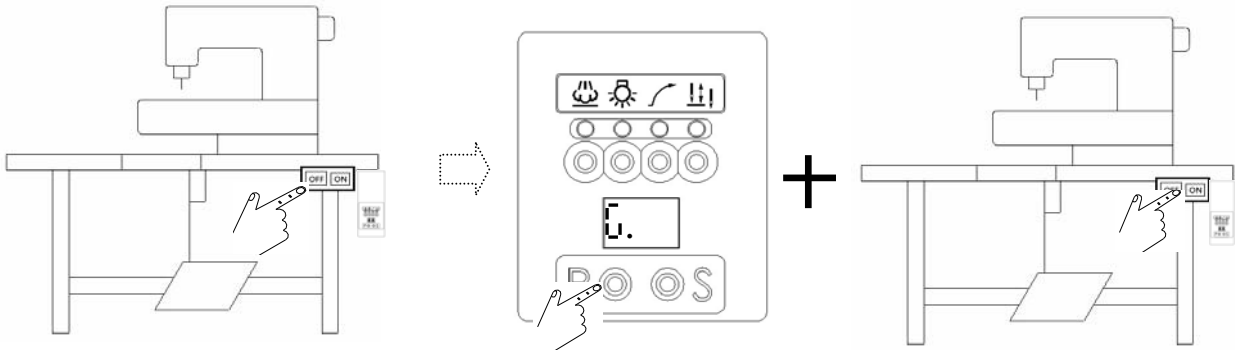

c. 再以 P 鍵找出欲設定的參數序號，如範例：【78】
d. 以 S 鍵進入其【內容值】畫面區。

e. 進入內容區後再按回 P 鍵調整所須之內容值。
f. 調整後須按下 S 鍵予以儲存確認。

註 1. 最後按下 S 鍵後，即自動回至【一般模式】的操作畫面。
註 2. 如下範例為：切線動作模式

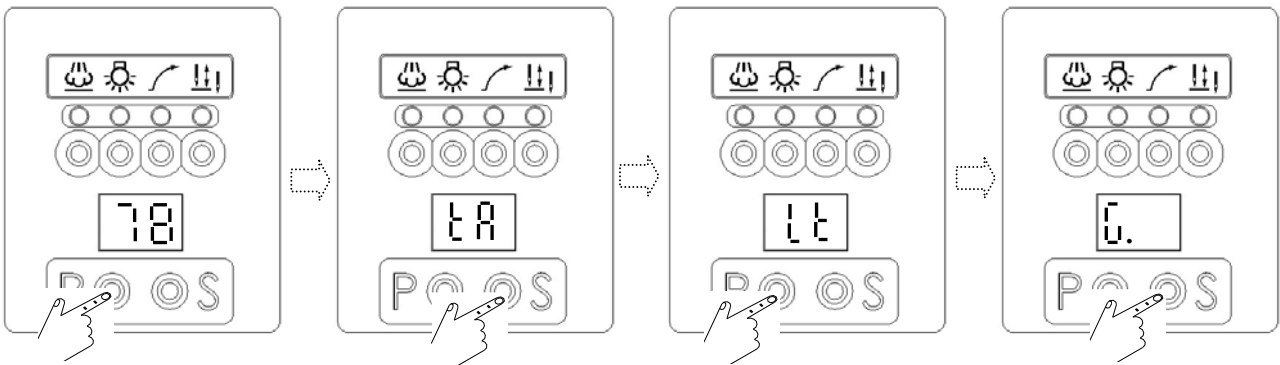

(4).在【參數模式 A 與 B】畫面區時，面板按鍵的功能與定義：

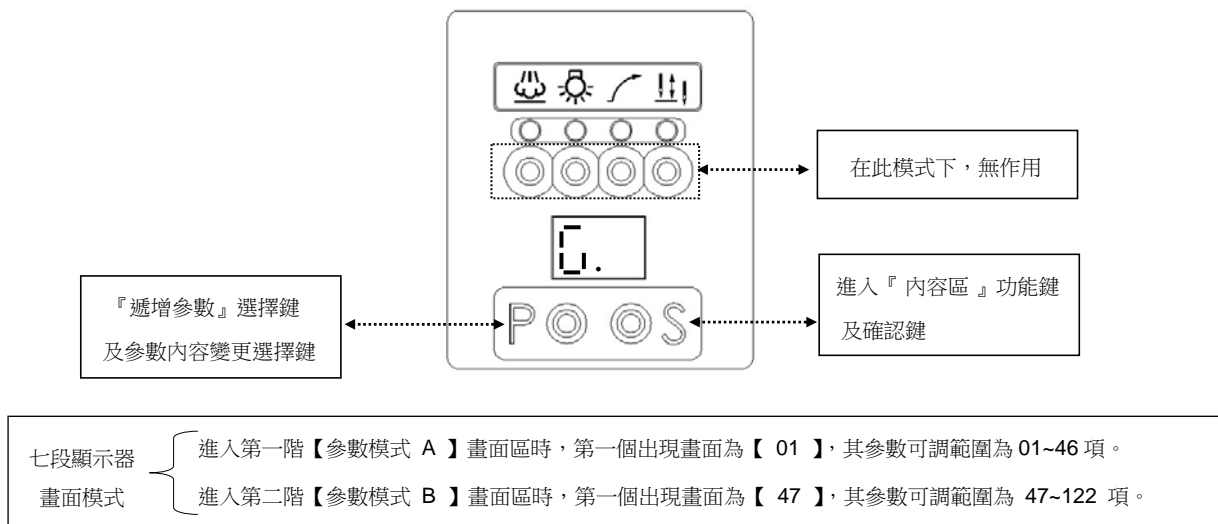

(5).如何進入『參數內容區』進行調整設定：

步驟一：先確定欲調整使用的參數代碼。（請參閱參數表或常用參數內容表）

步驟二：依隸屬之參數階級模式，按照其操作步驟進入參數模式區域，並找出欲調整的參數代碼。

（請參閱如何進入各階參數模式的操作步驟）。

步驟三：再進行所需參數內容值的調整：（在功能方面可直接以 P 鍵作切換，在速度、時間、

角度等方面請參照如下範例調整：例如參數【01】內容值的調整）：

A).將內容值或數值，調整比原預設值『還高』時的調整方式：

例如：將出廠預設值【01】【45】調高至【50】

請依第 5 章節的 (4) 或 (5) 敘述之 a、b、c 進至『內容區』畫面後，再依如下步驟逐步進行其數值調整設定。

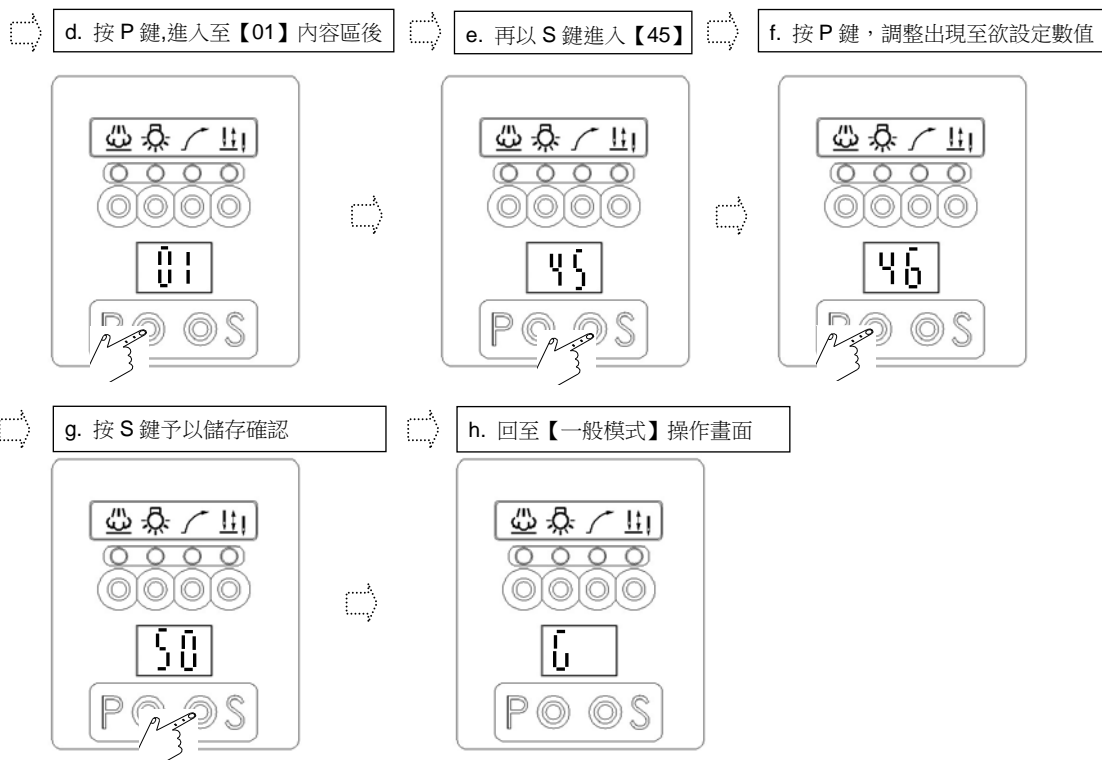

B).將內容值或數值，調整比原預設值『還低』時的調整方式：

例如：將出廠預設值【01】【45】4500轉，調低為4000轉時：

請依第5章節的(4)或(5)敘述之a、b、c進至『內容區』畫面後，再依如下步驟逐步進行其數值調整設定。

- d. 按 P 鍵,進入至內容區,如【01】 e. 按 S 鍵,進入【45】

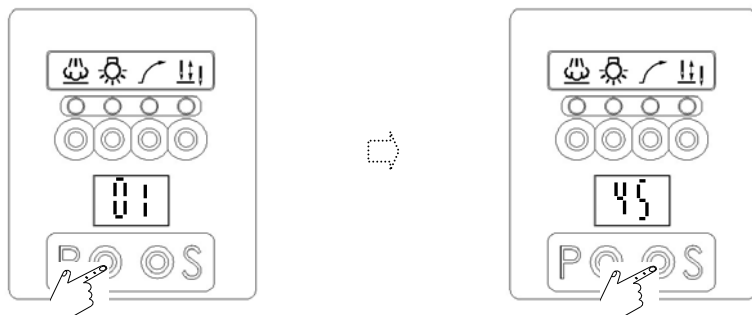

- f. 按 P 鍵調整,因只有一個方向滾動,當超過最高速時,會回到低速值,再調整至【40】 g.按 S 鍵予以儲存確認 h. 回到【一般模式】操作區畫面

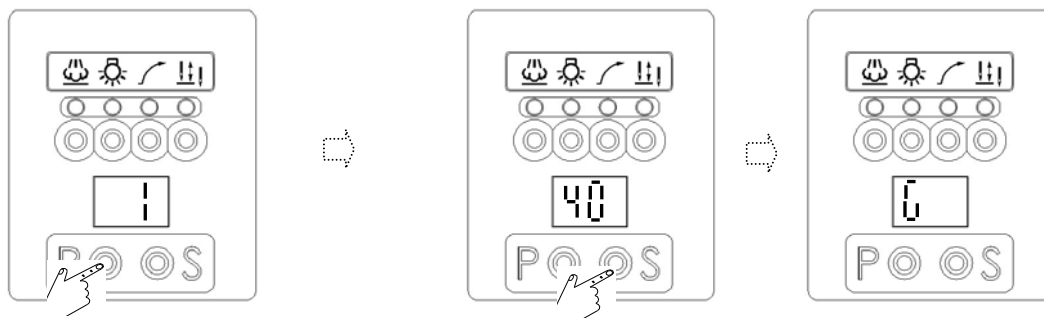

6.常用參數內容表：

參數代碼			參數定義	調整範圍	單位
實際值	顯示值	參數代碼			
按 P 鍵					
01	01	H	最高車縫速度	100-5000 spm	*100
02	02	SLM	起縫慢針模式	A/T	---
03	03	CNR	計件倍率設定	1-9	*1
07	07	S	起縫慢針速度	100-500 spm	*10
08	08	SLS	起縫慢針針數	1-9 stitches	*1
09	09	A	自動運轉速度	100-5000 spm	*100
40	40	WON	掃線功能選擇	ON/OFF	---
41	41	TM	切線程序選擇	ON/OFF	---
45	45	SP	車縫速度顯示	0-8000 spm	*100
46	46	DIR	電機旋轉方向	CC/CW	---
按 P 鍵+電源開啟					
47	47	MAC	機器碼	---	---
60	60	L	最低速度	100-500 spm	*10
61	61	T	切線速度	100-500 spm	*10
64	64	FO	壓腳全額出力時間調整	0-990 ms	*10
65	65	FC	壓腳佔空比時間調整	10-60%	*1
66	66	FD	馬達運轉延遲時間	0-990 ms	*10
70	70	HHC	取消半後踏抬壓腳	ON/OFF	---
75	75	SFM	安全開關模式選擇	NC/NO	---
122	22.	HL	最高速度上限	100-5000 spm	*100

※ 參數號碼畫面顯示 00.=100，0.0=200，0.0.=300；例如：06.=106 號參數。

※ 設定值會因型號不同而有不同值。

Model : TD series

Contents

	Page
1. Safety Precaution	
1.1 Safety of working environment.....	1
1.2 Safety precaution of installation.....	1
1.3 Safety precaution during operation.....	2
1.4 Safety precaution of maintenance and repair.....	2
1.5 Regulation of maintenance and repair.....	3
1.6 Danger / caution signs.....	3
1.7 Warranty period.....	3
2. Installation and Calibration	
(1). Installation of motor.....	4
(2). Installation of control box.....	5
(3). Installation of speed control unit.....	5
(4). Calibration of force of toeing forward / heeling backward.....	5
3. Power connection and grounding	
(1). Connection method of power supply cable.....	6
(2). Connection method of 3 Φ / 380 V to supply 1 Φ / 220 V.....	6
(3). The load balance when use a 1 Φ / 220 V motor used on a 3 Φ / 220 V power source.....	7
4. Name of Parts of Control Box	
(1). Front side of control box.....	8
(2). Rear side of control box: Connector Panel.....	8
5. Display mode of LED Display	
(1). Functions/ definition of keys of control panel in 【Normal Mode】.....	9
(2). Operation procedure to access display zone of the first stage of 【Parameter Mode A】.....	9
(3). Operation procedure to access second stage of 【Parameter Mode B】.....	10
(4). Functions/ definition of keys of control panel in 【Parameter Mode A and B】.....	11
(5). To access 【Parameter value zone】 to conduct parameter-setting.....	11
6. Table of commonly used Parameters.....	13

Appendix : Comparison Table between Characters of 7-Segment Display and Actual Value

1. Safety Precaution:

Before operation, please read this technical document and related manual of the machine head carefully and operate properly. Furthermore, installation and operation should be done by trained personnel.

When operating and installing TD Servo Motor series control box, please observe the following precautions. This driving product is only suitable for a specific range of sewing machines and must not be used for other purposes.

1.1 Safety of working environment:

(1). Power voltage:

The power voltage applied should be within the range of $\pm 10\%$ of the specification on the name plate of the control box.

(2). Interference of electromagnetic waves:

Keep away from the high frequency magnetic wave devices/ transmitters to avoid the resulting electromagnetic waves from affecting this driving equipment, leading to abnormal operation.

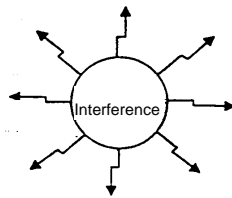

Keep away

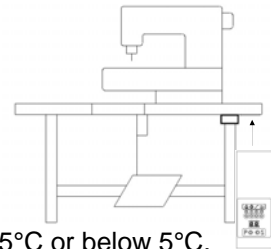

(3). Temperature:

- a. Please don't operate in places with room temperature above 45°C or below 5°C.
- b. Please don't operate in places under direct sun light or outdoors.
- c. Please don't operate near the heater.
- d. Please don't operate in places with relative humidity below 30 % or above 95% or places with dew.

(4). Ambience:

- a. Please don't operate in dusty places, places with corrosive materials.
- b. Please don't operate in places with volatile gases.

1.2 Safety Precaution of Installation:

- (1). Motor and control box: please follow the instruction in this manual for proper installation.
- (2). Accessories: When installing other optional parts or accessories, please turn off the power switch and remove the plug from outlet.
- (3). Power cable:
 - a. Avoid external objects on power cord or excessive distortion of power cord.
 - b. When plugging the cord into the outlet, ensure that the power voltage applied should be within the range of $\pm 10\%$ of the specification on the name plates of the control box.

※ **Attention : If the power specification of the control box is AC 220V, please don't connect to AC 380V power outlet. Otherwise, error code E4 will appear. In this case, please turn off the power switch immediately and check the power voltage. Continuous supply of 380V over 5 minutes might damage the PCB, endangering the safety of users.**



(4). Grounding:

- a. To prevent the interference of noises and current leakage, all grounding works should be done properly (including machine, motor, control box).

Single phase (AC220V)

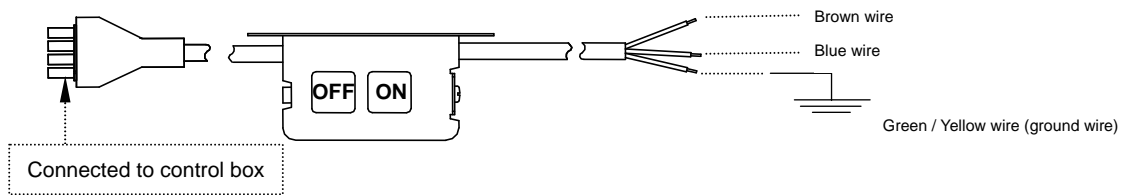

 Grounding works should be done properly on ground wire (Green/ Yellow).
If grounding is not done, leakage current will cause discomfort or injury to human body.

- b. The grounding wire of the power cord should be connected to the system ground wire of the production factory with conducting wire of appropriate size and connector and this connection should be permanently fixed.

1.3 Safety Precaution during Operation:

- (1). When powering for the first time, please operate the sewing machine in low speeds and check whether the rotation direction is correct.
- (2). When the sewing machine is in operation, avoid contact with any moving parts such as scale, needles, etc.
- (3). All moving parts should be properly isolated with the provided protective devices to avoid the body contact and foreign objects should not be inserted within these devices.
- (4). Please do not operate with other safety devices removed.

1.4 Safety Precaution of Maintenance and Repair:

Before performing the following actions, please turn off the power:

- (1). When disassembling motor or control box, or when inserting any connecting plugs onto or removing any connecting plugs from the control box.
- (2). Control box has high voltage inside, so after turning off the power, wait 5 minutes or longer before opening the control box cover.

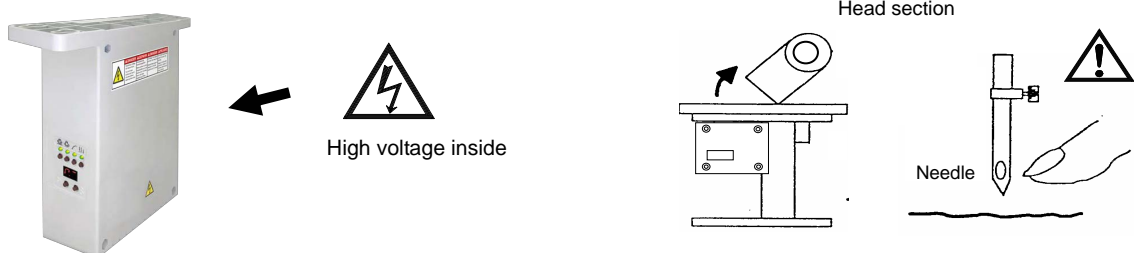

- (3). When raising the head section of machine or when changing machine needle or winding thread. (as shown above)
- (4). When repairing or making any mechanical adjustments.
- (5). When machine is not in use.

1.5 Regulation of Maintenance and Repair:

- (1). Repair and maintenance should be performed by the properly trained technical personnel.
- (2). Please do not place any miscellaneous items near the vent of motor thereby blocking the ventilation, particularly the rear cover of motor should not have dust, paper scraps, cloth scraps, etc to avoid the motor from heating up.
- (3). Please do not hit this product body or motor shaft with any unsuitable objects such as wooden hammer, iron hammer, etc.
- (4). All spare parts used for repair should be provided or approved by our company.

1.6 Danger/ caution signs:



This marking symbol indicates that during the installation of device, if error occurs, there can be risks leading to injury to human body or damage to the machine. Therefore, any place of machine with such probability of dangers will have this marking.



This marking symbol indicates that there will be high electrical voltages, places with electrical probability of dangers.

1.7 Warranty Period:

Under normal working condition and operation without human errors, the guarantee of this device entitles repair without any compensation within 18 months from the factory shipping date.

2. Installation and Calibration:

(1). Installation of Motor:

M5 DD type:

Installation Procedure for overlock machine:

1. Remove the cooling fan and pulley of sewing machine.
2. Place the accompanying coupling (A) inside the shaft of sewing machine, fix the cooling fan close to shaft surface. Use the shaft bushing (B) to fix the coupling firmly within the shaft. Caution: if the shaft surface does not reserve any screw hole, then there is no need to assemble the shaft bushing.
3. Fix the setting screw (C) of coupling. Caution: fix the special claw-shaped setting screw of coupling onto the flat surface or indentation (D) of shaft.
4. Fix the M5 motor (E) onto machine head. Caution: there is foolproof design between the coupling at machine head end and the coupling at motor end. During assembly, pay attention to the reciprocal direction.
5. Fix the insulation cover (F) of motor.

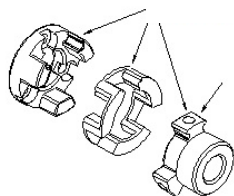
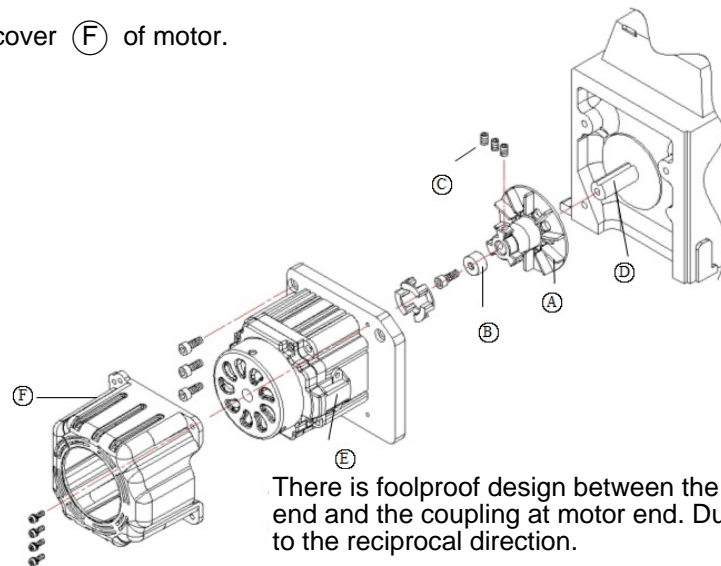

Fix the special claw-shaped setting screw of coupling onto the flat surface or indentation (D) of shaft.

Calibration of position for overlock machine:

1. Remove the hand wheel of sewing machine.
2. Rotate the shaft so that the scale stops at the highest point (or the point of "needle-up" position specified by the sewing machine).
3. Rotate the encoder disc so that screw (A) is aligned with the position of the wiring outlet of motor.

Remark: the above-mentioned calibration is the standard calibration method.

If the position is found to be inaccurate, please perform finetuning by oneself.

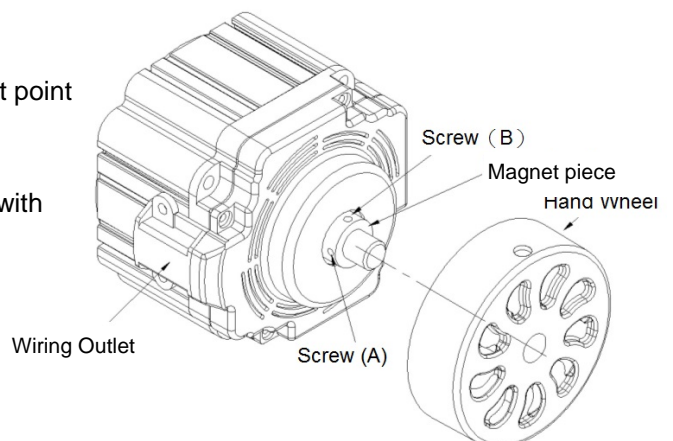

(2). Installation of Control Box:

a). Reserve space of more than 100 mm at the right side of the pedal

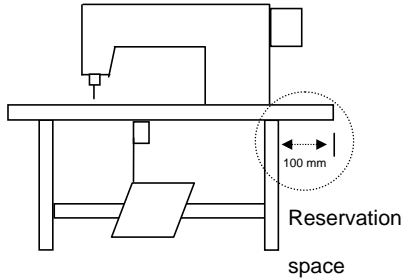

b). Install the TD control box underneath the table.

Diagram with dimensions



c). Illustration diagram after installation

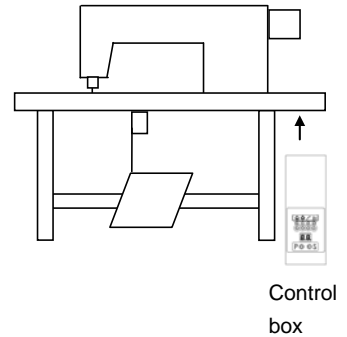

(3). Installation of Speed Control Unit:

a). Fix the bracket of speed control unit underneath the table

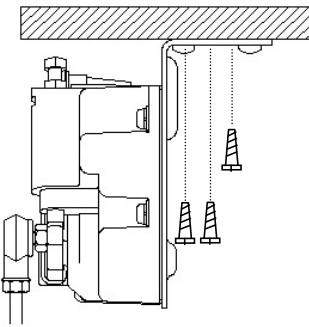

b). Illustration diagram after installation

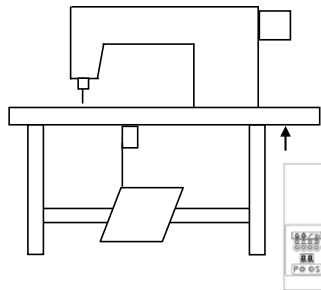

(4). Calibration of force of toeing forward/ heeling backward (Speed Control Unit):

Parts of speed control unit: see figure

- A: Spring for calibrating force of toeing forward
- B: Bolt for calibrating force of heeling backward
- C: Pedal arm
- D: Pitman rod for pedal

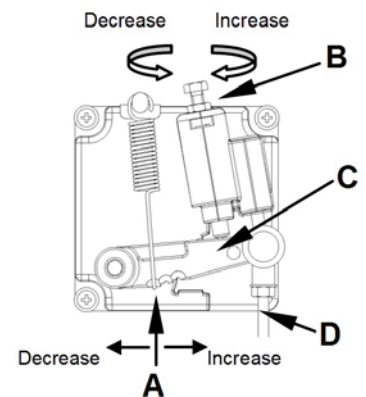

	Calibration requirement	Calibration result
1	Calibration of force of toeing forward	When spring A leans towards right, force is increased. When spring A leans towards left, force is reduced.
2	Calibration of force of heeling backward	Turn bolt B upwards (↶) to decrease force. Turn bolt B downwards (↷) to increase force.
3	Calibration of stroke length of pedal	Secure Rod D at right-side hole to increase length. Secure Rod D at left -side hole to reduce length.

3. Power Connection and Grounding:

(1). Connection method of power supply cable:

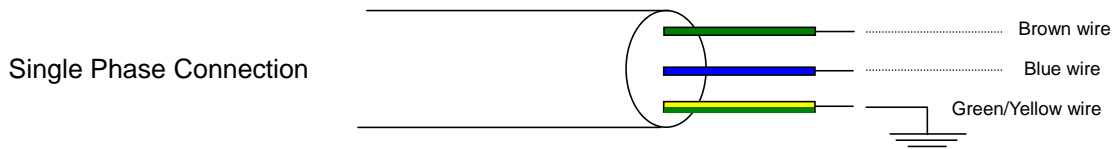



The green/ yellow wire is the ground wire. System grounding works must be done properly. Please contact qualified electrical engineering personnel to perform the works.

(2). When the configuration of the power supply system is three-phase, four-wire 380V, the connection method in order to supply single-phase 220 V to the product is as follows.



Caution: If the system configuration does not have a **【neutral (point) line】**, the single-phase 220V servo motor is not suitable for use in this place. Please reorder the three-phase 380V servo motor model from the original supplier.

Caution: Configuration of neutral (point) line is necessary

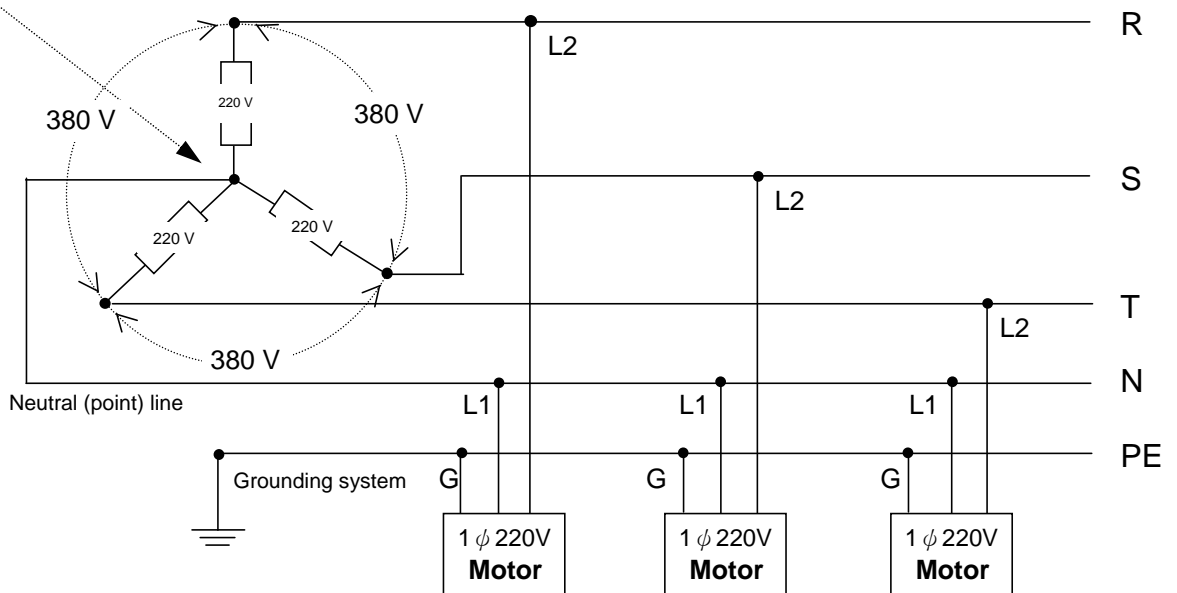

(3).When wishing to use three-phase 220V voltage for single-phase 220 V servo motor, care must be taken regarding the load balance in the configuration:

When connecting a considerable number of sewing machines in the configuration, the balance of the R, S, and T phases among the three phases should be considered as shown in the following figure:

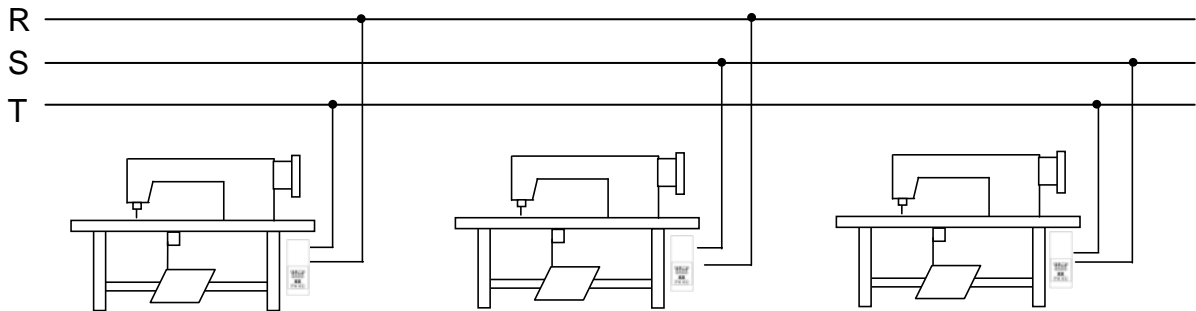

Caution:

Please switch off the power supply before opening the control box cover
Perform the following plug-in actions only after about 5 minutes.



High Voltage inside

4. Name of Parts of Control Box:

(1). Front side of Control Box:

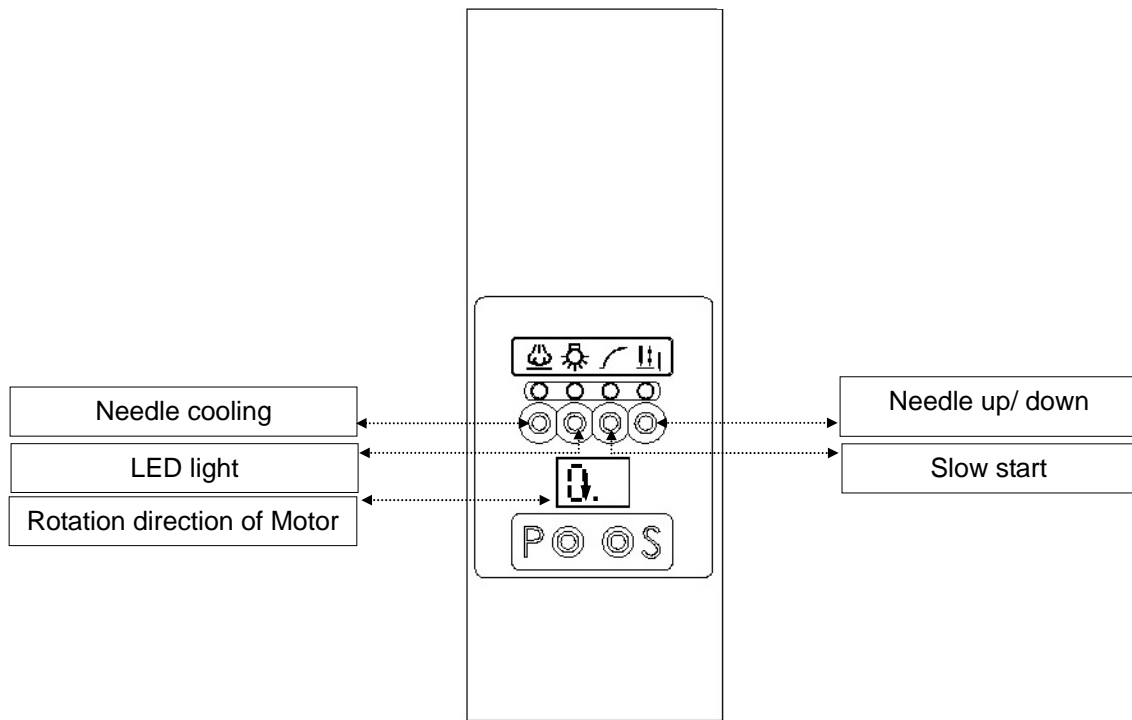

(2). Rear side of Control Box: Connector Panel

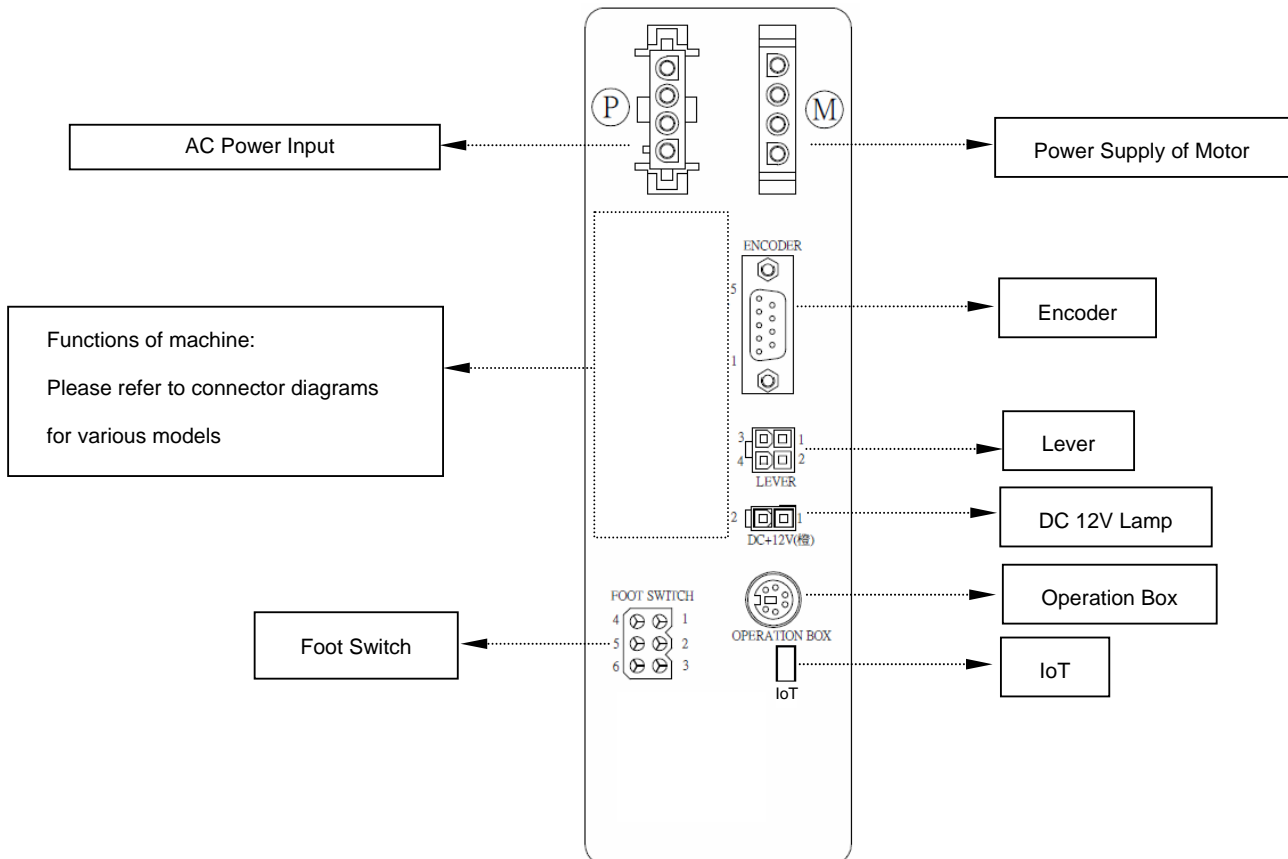

TD654-0-7K-2端子座圖

Connector panel diagram

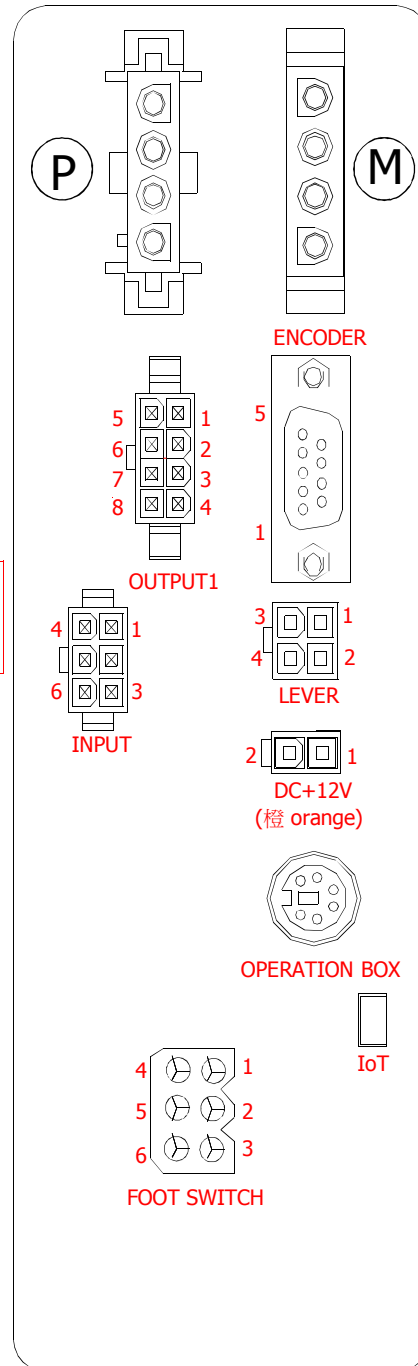
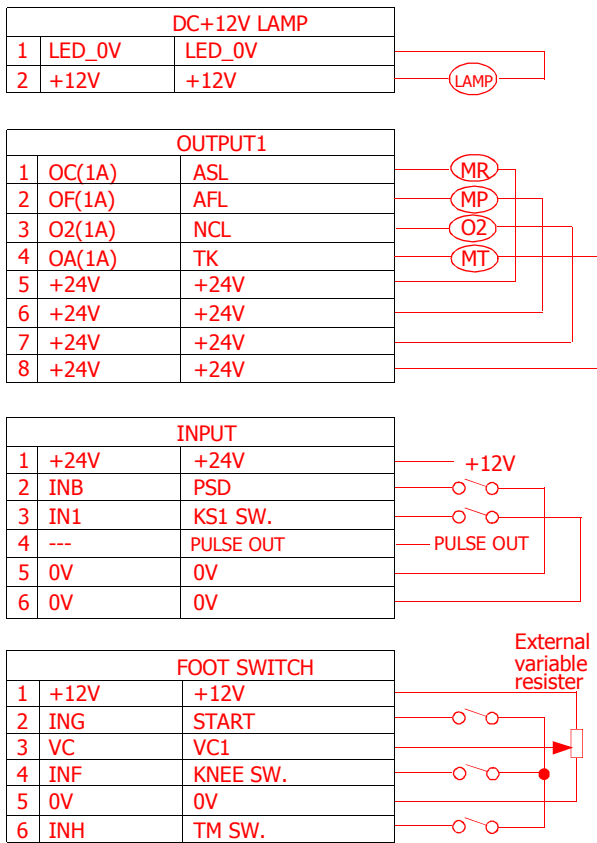

ENCODER	
1	+5V
2	UP
3	DOWN
4	A PHASE
5	B PHASE
6	R
7	S
8	T
9	0V

LEVER	
1	+5V
2	VC
3	KNEE SW.
4	0V

OPERATION BOX	
1	U SW.
2	R1in
3	+12V
4	T1out
5	0V
6	CKU

IoT	
1	+5V
2	T1out
3	R1in
4	---
5	0V

TD654-0-LF-2 端子座圖

Connector panel diagram

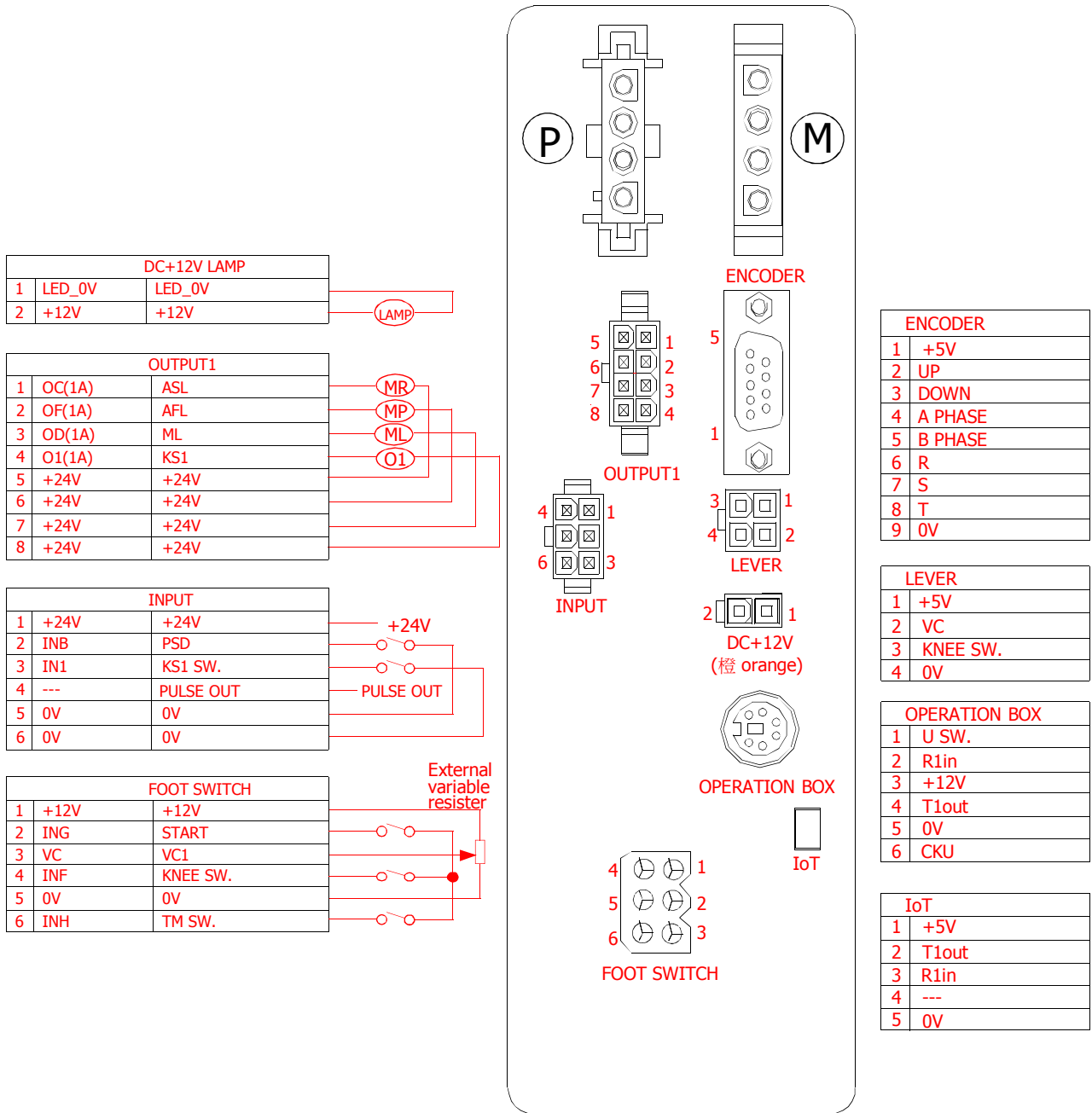

TD656-4-HF-2 端子座圖

Connector panel diagram

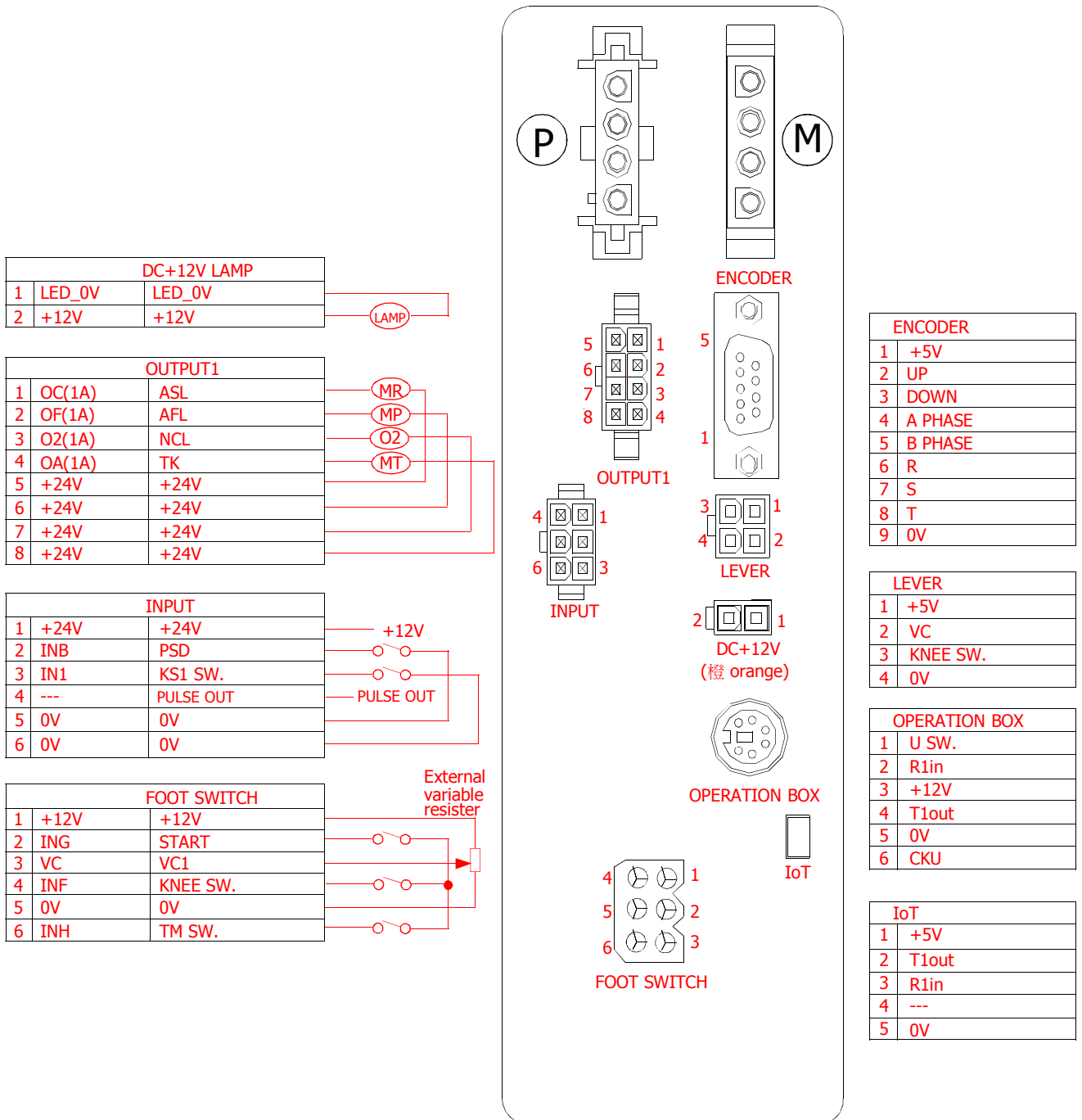

5. Display mode of LED Display:

(1). Functions and definition of keys of control panel in the display zone of **【Normal Mode】**:

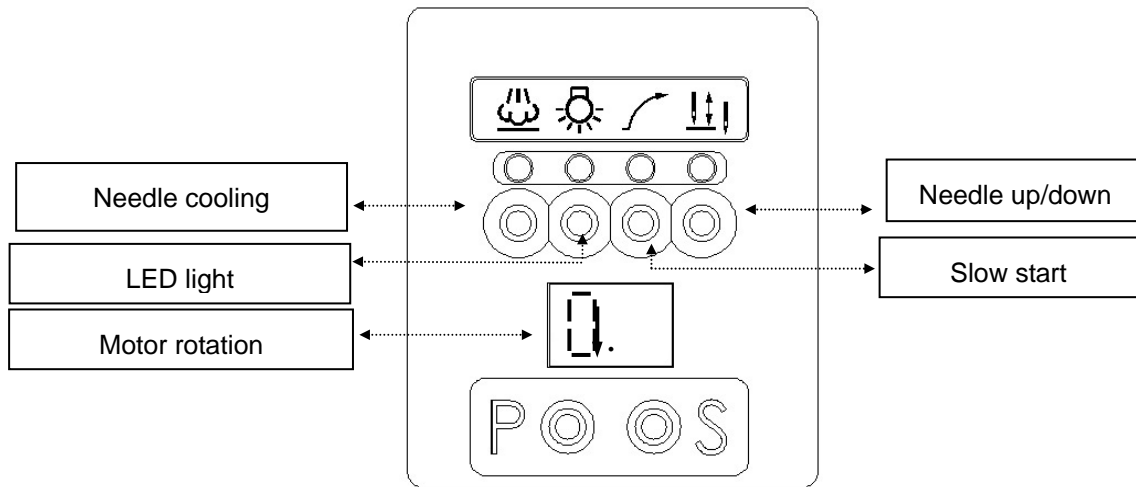

(2). Operation procedure to access display zone of the first stage of **【Parameter Mode A】**:
(Only parameter codes: 01 ~ 46 available for selection in Zone A)

- | | | |
|---|--|--|
| <p>a. Under the display zone of 【Normal mode】, press P key to access the display of first parameter code 【01】 of 【Mode A】.</p> | <p>b. Subsequently, press P key to access the required parameter sequence no. eg.: 【05】.</p> <p>c. Press S key to access the display zone of the corresponding 【parameter value】</p> | <p>d. After accessing the zone of parameter value, press P key again to adjust the required value.</p> <p>e. Press S key to return to operation zone after saving the value.</p> |
|---|--|--|

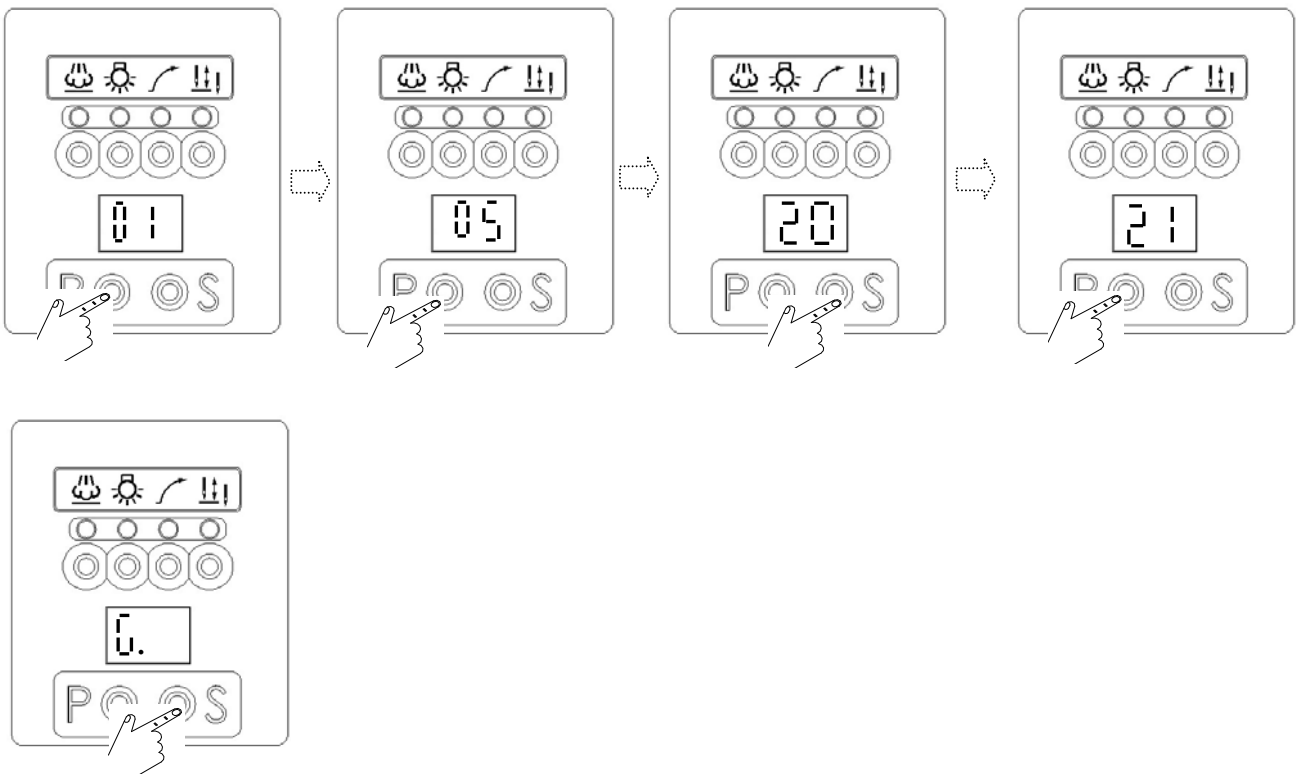

(3). Operation procedure to access display zone of the second stage of **【Parameter Mode B】** : (Range of parameter codes: 47~122 available for selection in Zone B)

a. If in operation, please turn off the power switch first.

b. Press and hold P key. Meanwhile, turn on the power switch to access the first display zone **【47】** of display zone **【Parameter mode B】** .

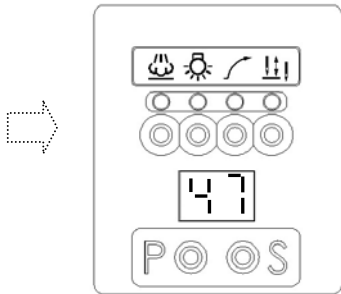
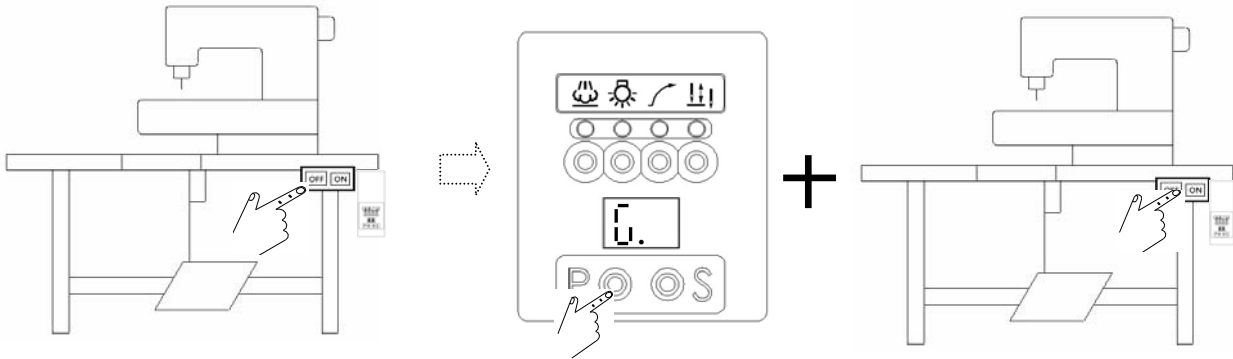

c. Subsequently, press P key to select the parameter code to be set. For example: **【78】**
 d. Use S key to enter the display zone of **【parameter value】** .

e. After entering this zone, press P key again to adjust the required value.
 f. After adjustment, press S key to confirm saving.

Note 1. Finally, press S key to return automatically to the operation zone of **【Normal Mode】** .
 Note 2. Following example: Trimming mode.

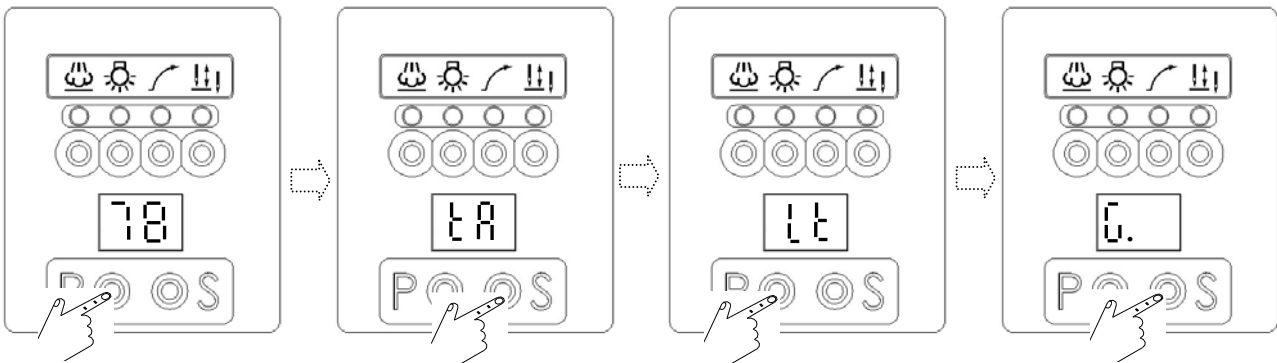

(4). Functions and definition of keys of control panel in the display zone of

【Parameter Mode A and B】 :

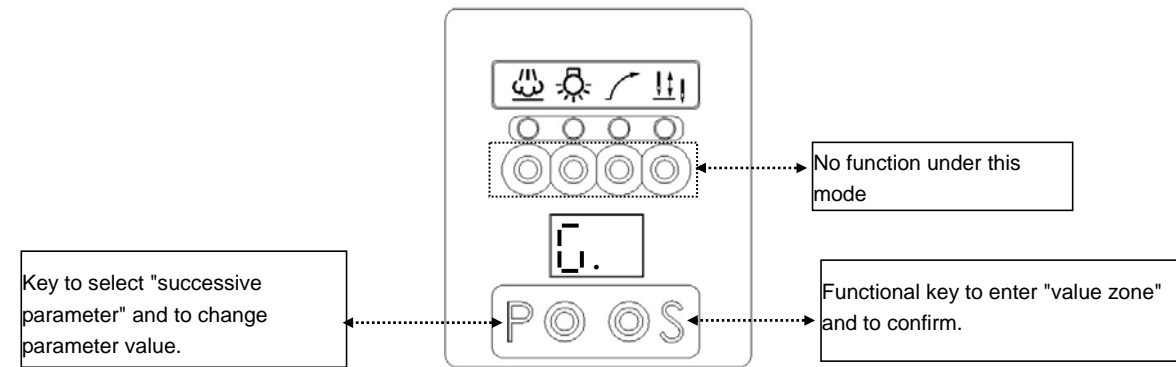

Display mode of 7-segment display

- After entering the display zone of the first stage of 【Parameter Mode A】 , the first display appears as 【01】 with parameters available for adjustment ranging 01~46.
- After entering the display zone of the second stage of 【Parameter Mode B】 , the first display appears as 【47】 with parameters available for adjustment ranging 47~122.

(5). To access 【Parameter value zone】 to conduct parameter-setting.

Step 1: First confirm the parameter code to be adjusted. (Please refer to the parameter list or definition table of commonly used parameters)

Step 2: Based on the associating hierarchical mode of parameters, follow its operation procedure to access the respective zone of parameter mode and select the parameter code to be adjusted. (Please refer to the operation procedure to access each level of parameter mode).

Step 3: Subsequently, conduct adjustment of the required parameter value. (For function, use P key to switch Function whereas for speed, timing and angle etc., please refer to the following example to conduct adjustment: For example, adjustment of value of parameter 【01】):

A). The adjustment method to adjust the value to be "greater" than the originally preset value:

For example: To increase the factory preset value 【01】 【45】 to 【50】

(After following the instruction in section (4) or (5) in chapter 5 to access the display of "value zone", subsequently conduct the adjustment of its value according to the following procedure.)

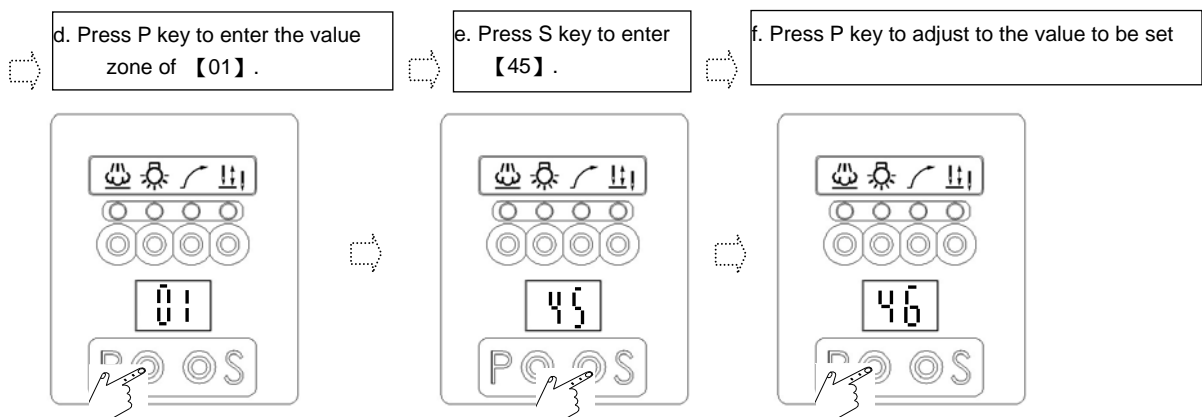



g. Press S key to save and confirm.



h. Return to the operation display of **【Normal Mode】**.

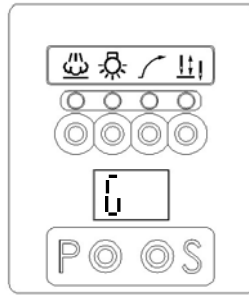
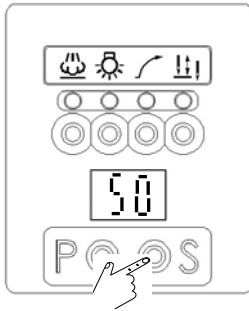

B). The adjustment method to adjust the value to be "lower" than the originally preset value:

For example: To decrease the factory preset value **【01】【45】** from 4500 to 4000:

(After following the instruction in section (4) or (5) in chapter 5 to access the display of "value zone", subsequently conduct the adjustment of its value according to the following procedure.)



d. Press P key to enter the value zone of **【01】**.



e. Press S key to enter **【45】**.

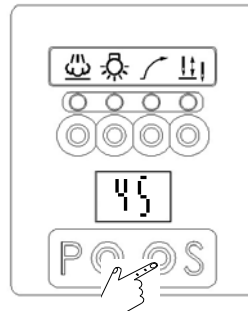
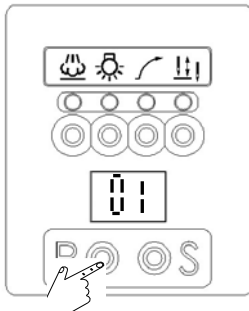

f. Press the P key to adjust. As there is only one rolling direction, when the maximum speed is exceeded, it will return to the low speed value. Then, adjust to **【40】**.



g. Press S key to save and confirm.



h. Return to the operation display of **【Normal Mode】**

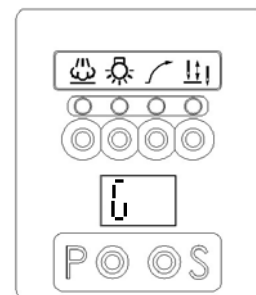
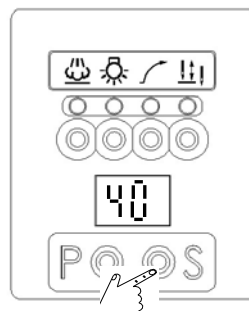
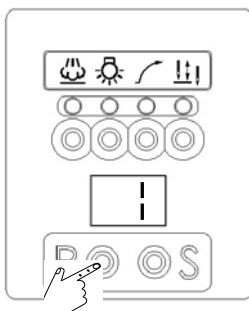

6. Table of commonly used Parameters:

Parameters Code			Definition of Parameter	Calibration range	Unit
Actual value	Display value	Code			
Press P Key					
01	01	H	Maximum sewing speed.	100-5000 spm	*100
02	02	SLM	Mode of slow start	A/T	---
03	03	CNR	Setting of counter ratio.	1-9	*1
07	07	S	Speed of slow start.	100-500 spm	*10
08	08	SLS	Stitch numbers of slow start.	1-9 stitches	*1
09	09	A	Speed of automatic operation.	100-5000 spm	*100
40	40	WON	Selection of wiper function.	ON/OFF	---
41	41	TM	Selection of trimmer sequence.	ON/OFF	---
45	45	SP	Display of sewing speed.	0-8000 spm	*100
46	46	DIR	Rotation direction of motor.	CC/CW	---
Press P Key + Power ON					
47	47	MAC	Machine Code.	---	---
60	60	L	Minimum speed.	100-500 spm	*10
61	61	T	Speed of thread-trimming.	100-500 spm	*10
64	64	FO	Setting of time of full output for foot-lifting solenoid.	0-990 ms	*10
65	65	FC	Setting of time of duty cycle for foot-lifting solenoid.	10-60%	*1
66	66	FD	Setting of delay time of motor operation.	0-990 ms	*10
70	70	HHC	Cancellation of function of raising pressure foot lifter by half-heeling backward.	ON/OFF	---
75	75	SFM	Mode selection of safety switch	NC/NO	---
122	22.	HL	Upper limit of maximum speed.	100-5000 spm	*100

※Displaying parameter number 00.=100, 0.0=200, 0.0.=300; for example: 06.=106 parameter.

※The setting values may vary depending on the model.

七段顯示器字體與實際數值對照表：

Comparison Table between Characters of 7-Segment Display and Actual Value

數值字體部份：（Arabic Numerals）

實際數值 Actual Value	0	1	2	3	4	5	6	7	8	9
七段顯示器 7-Segment Display	0	1	2	3	4	5	6	7	8	9

英文字體部份：（English Alphabet）

英文數字 Actual Value	A	B	C	D	E	F	G	H	I	J
七段顯示器 7-Segment Display	A	b	C	d	E	F	G	H	i	U
英文數字 Actual Value	K	L	M	N	O	P	Q	R	S	T
七段顯示器 7-Segment Display	t	L	n	n	o	P	q	r	S	r
英文數字 Actual Value	U	V	W	X	Y	Z				
七段顯示器 7-Segment Display	U	u	B		P	≡				



高林股份有限公司
KAULIN MFG. CO., LTD.

由於對產品的改良及更新，本產品使用說明書中與零件圖之產品及外觀的修改恕不事先通知！
The specification and/or the equipment described in the instruction book and parts list
are subject to change because of modification with out previous notice
700KS/KST 700KS-LFD6K F007K FNC VC008 VC008A/B HF008A HF008.MAY.2022